

**SEITE
PAGE
PAGINA**

ULTRA



1 - 87

SYMBOLS



88 - 100

ULTRA FINE



101 - 116

ULTRA • SYMBOLS • ULTRA FINE



117 - 128

ULTRA



HPL

AL





ULTRA

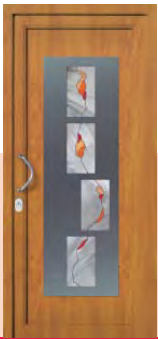

DV-170
GL170V2



DV-171
GL171V1



DV-172
GL172V3



DV-173
GL173V1



DV-174
GL174P2



DV-175
GL175V1

seite • page • pagina

6

7

8

9

10

11



DV-176
GL176V1



DV-177 N



DV-178



DV-179



DV-180
GL180V2



DV-181
GL181V1

seite • page • pagina

12

13

14

15

16

17



DV-182



DV-183
GL183V2



DV-184
GL184V3



DV-185
GL185P1



DV-186
GL186V2



DV-187

seite • page • pagina

18

19

20

21

22

23



DV-203



DV-204
GL204V2



DV-205



DV-206
GL206V1



DV-207
GL207V2



DV-208
GL208V1

seite • page • pagina

24

25

26

27

28

29



DV-209
GL209V2

30



DV-211

31



DV-214

32



DV-215

33



DV-216

34



DV-219

35

seite • page • pagina



DV-220

36



DV-222
GL222V1

37

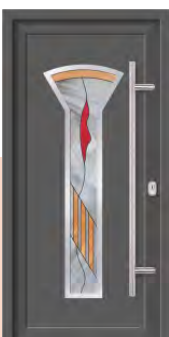

DV-224
GL224V2

38



DV-226

39



DV-229
GL229V2

40



DV-230
GL230V2

41

seite • page • pagina

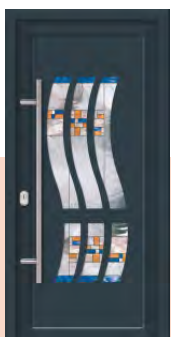

DV-232
GL232V1

42



DV-233
GL233V2

43



DV-235
GL235V2

44



DV-239
GL239V1

45



DV-240

46



DV-242

47

seite • page • pagina



DV-244
GL244V2

48



DV-246

49



DV-248

50



DV-254
GL254V2

51



DV-256
GL256V2

52



DV-257

53

seite • page • pagina



ULTRA



DV-259
GL259V3



DV-261
GL261V2



DV-263
GL263V1



DV-264
GL264V1



DV-265
GL265V2



DV-267

seite • page • pagina

54

55

56

57

58

59



DV-270
GL270V2



DV-273
GL273V2



DV-275
GL275V2



DV-277
GL277V2

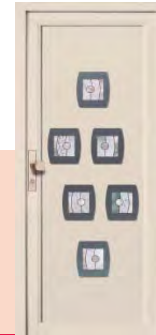

DV-279
GL279V1



DV-282
GL282V1

seite • page • pagina

60

61

62

63

64

65



DV-284



DV-286
GL286V3



DV-287



DV-291



DV-293
GL293V1



DV-421

seite • page • pagina

66

67

68

69

70

71



DV-422
GL422V1



DV-424



DV-425
GL425V1

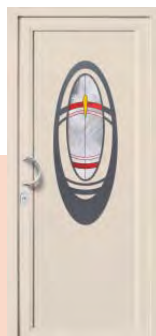

DV-426
GL426V1



DV-427



DV-428

seite • page • pagina

72

73

74

75

76

77



DV-429
GL429V1

78



DV-430
GL430V1

79



DV-431
GL431V1

80



DV-432
GL432V1

81



DV-433 N
GL433NV1

82



DV-434
GL434V1

83

seite • page • pagina



DV-435

84

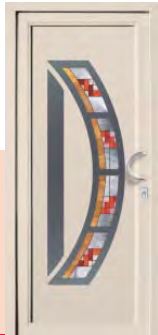

DV-436
GL436V2

85



DV-437

86



DV-439

87

seite • page • pagina





DV-170 GL170V2



DV-170



DV-170



DV-170 GL170V1

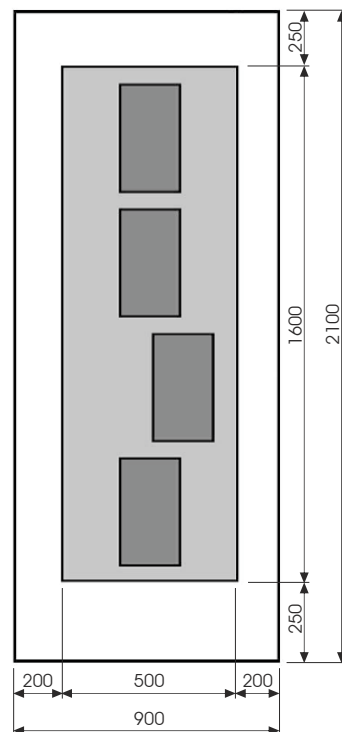



ULTRA

HPL • AL



DV-171 GL171V1



DV-171

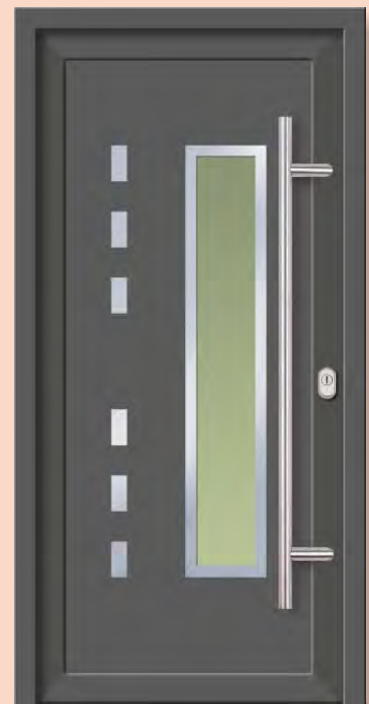
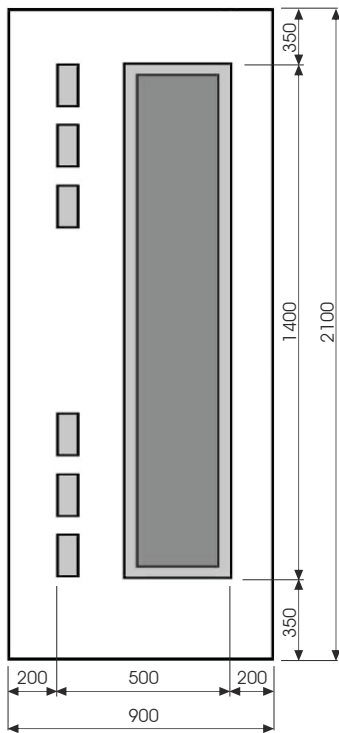

DV-171



DV-172 GL172V3



DV-172



DV-172 GL172V1



DV-172

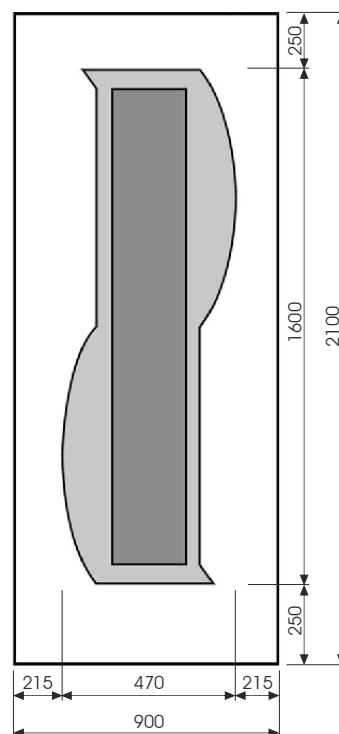



DV-173 GL173V1



DV-173

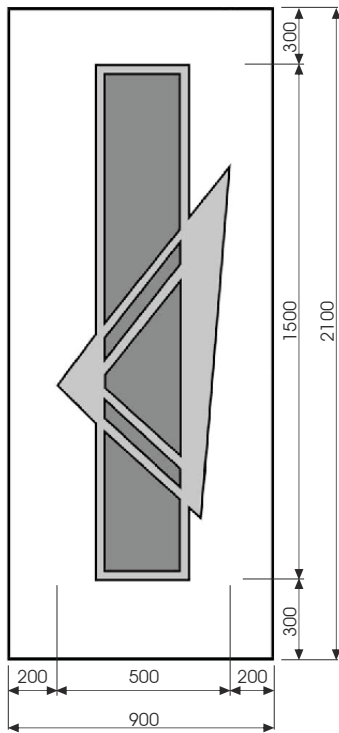

DV-173



DV-174 GL174P2



DV-174



DV-174

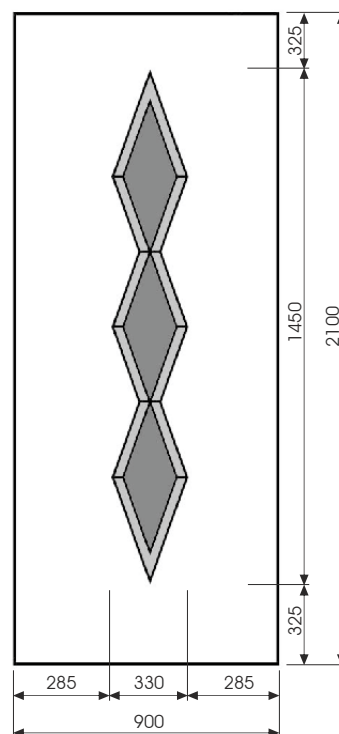



DV-175 GL175V1

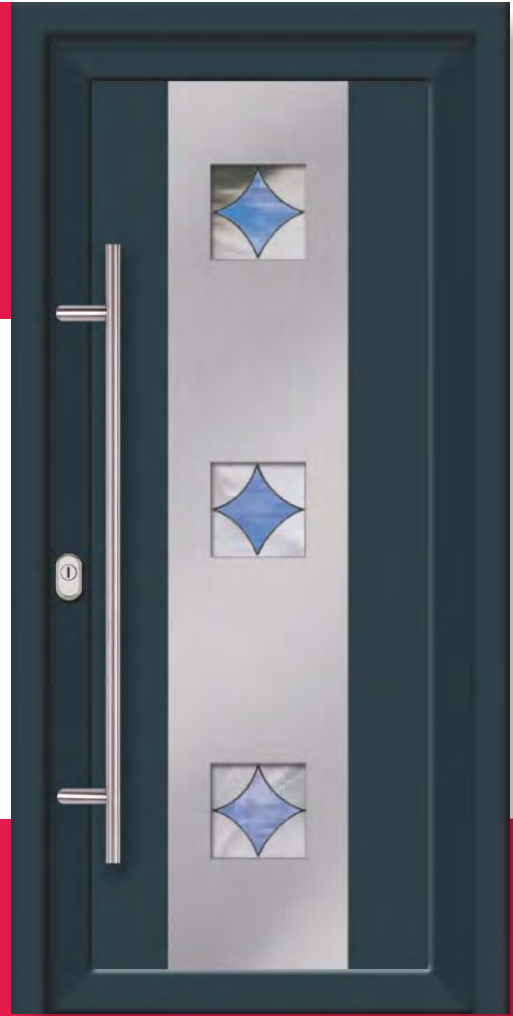

DV-175

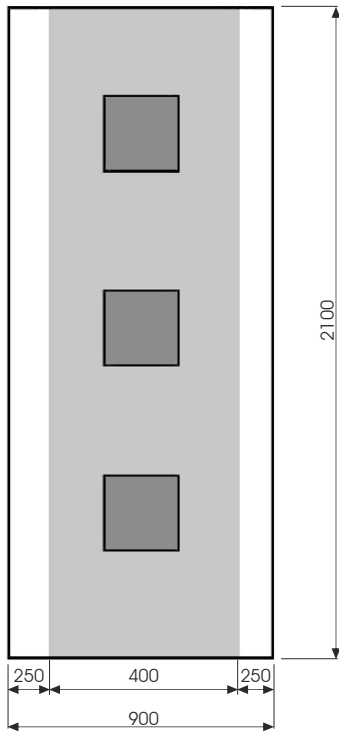

DV-175



DV-175 GL175V2



DV-176 GL176V1



DV-176



DV-176

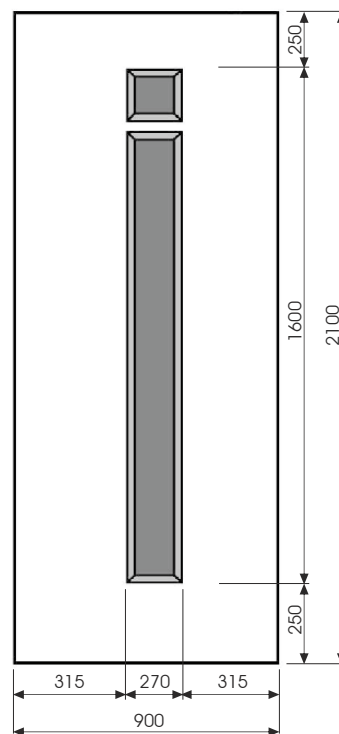



ULTRA

HPL • AL



DV-177 N

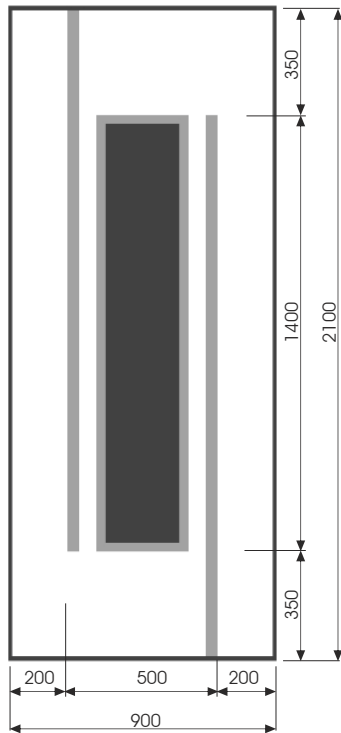

DV-177 N GL177NP1



DV-178



DV-178 GL178P1

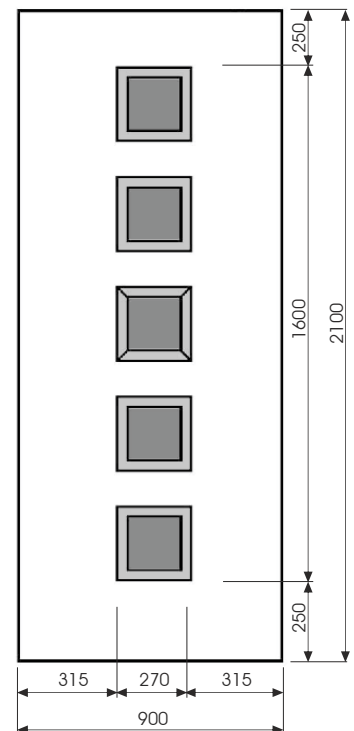



ULTRA

HPL • AL

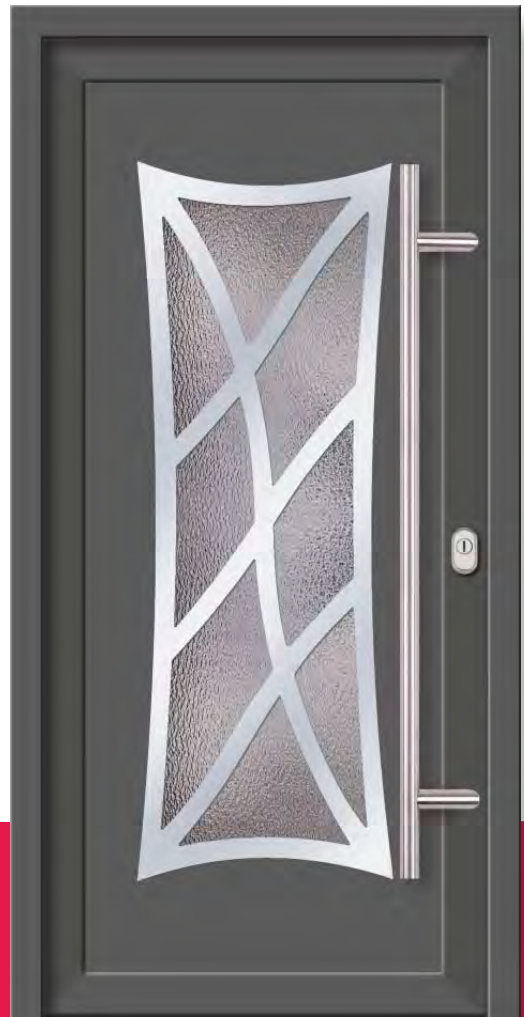

DV-179

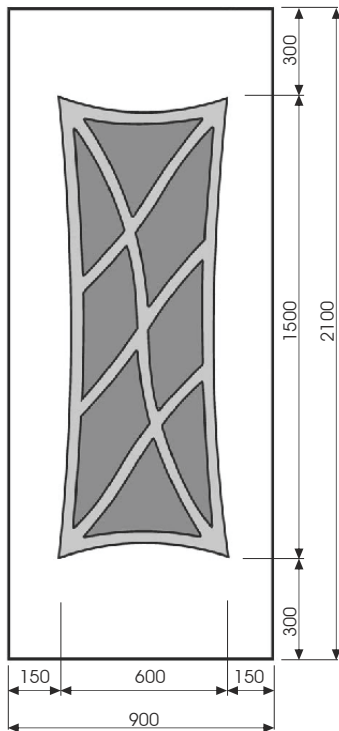

DV-179 GL179V2



DV-180 GL180V2



DV-180



DV-180 GL180V1

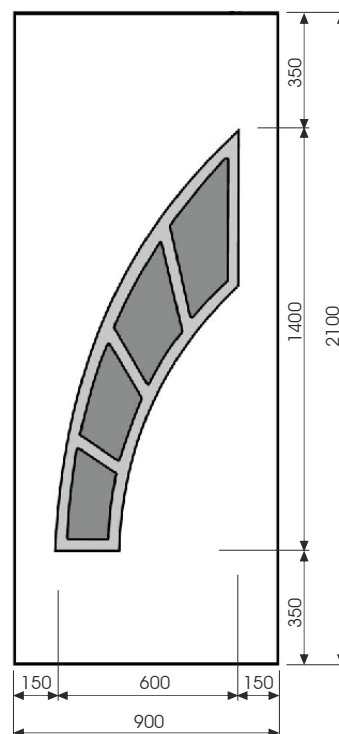



DV-181 GL181V1



DV-181

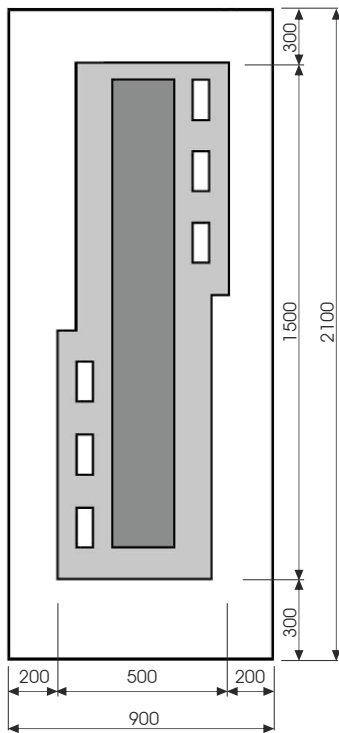

DV-181



DV-181 GL181V2



DV-182



DV-182 GL 182P1

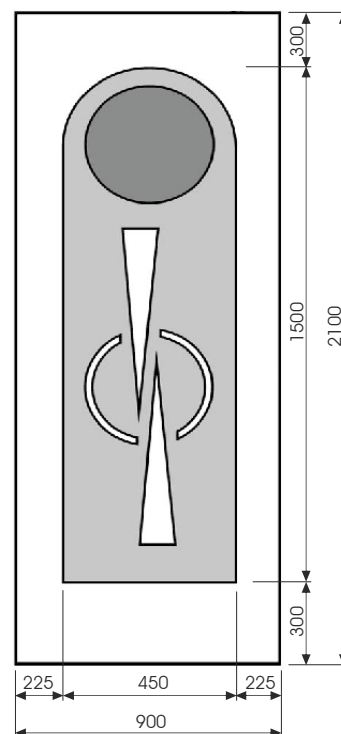



DVF-183 D GL183V1



DV-183 GL183V2

DV-183

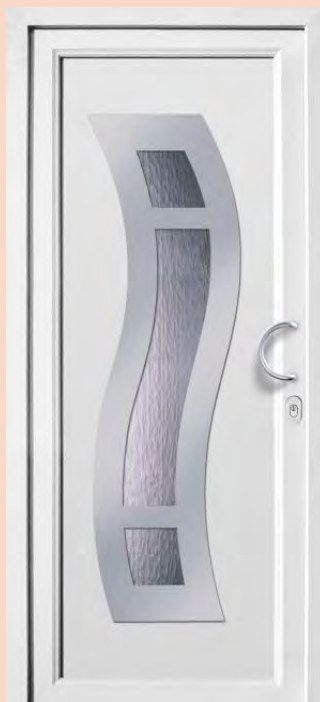
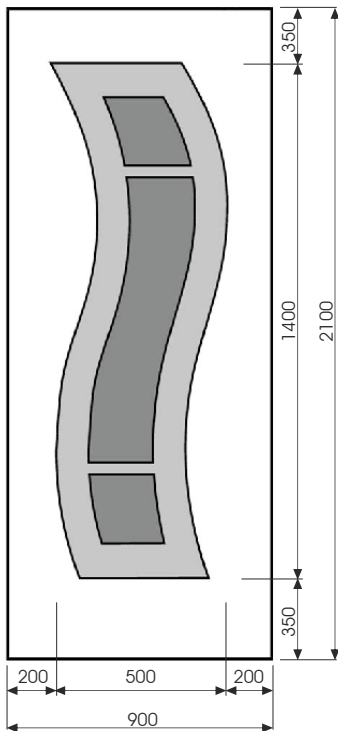

DV-183

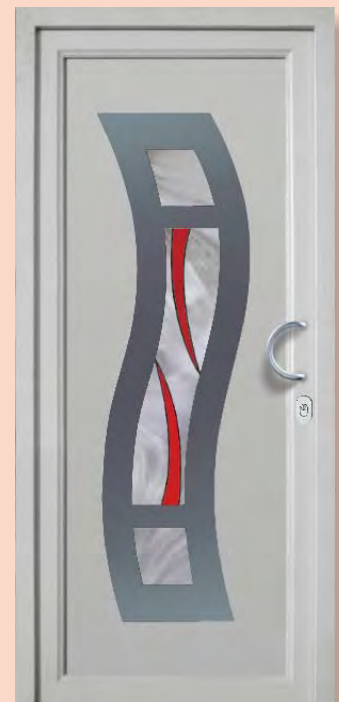

DV-183 GL183V3



DV-184 GL184V3



DV-184 GL184P2

DV-184



DV-184 GL 184V1



DV-184 GL 184V2

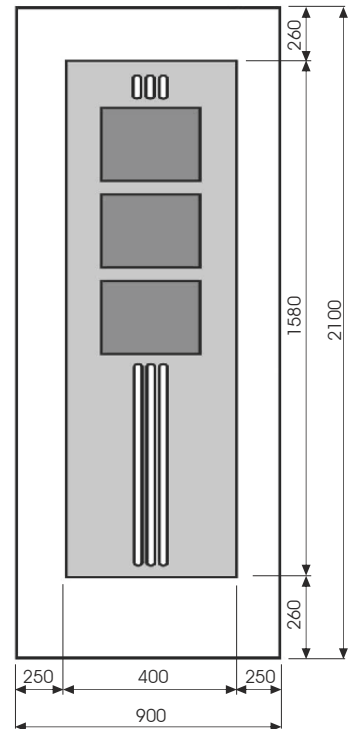



DV-185 GL185P1



DV-185

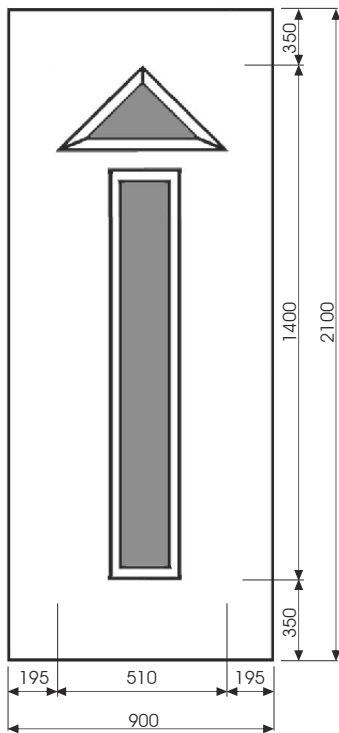

DV-185



DV-186 GL186V2



DV-186



DV-186 GL186V1

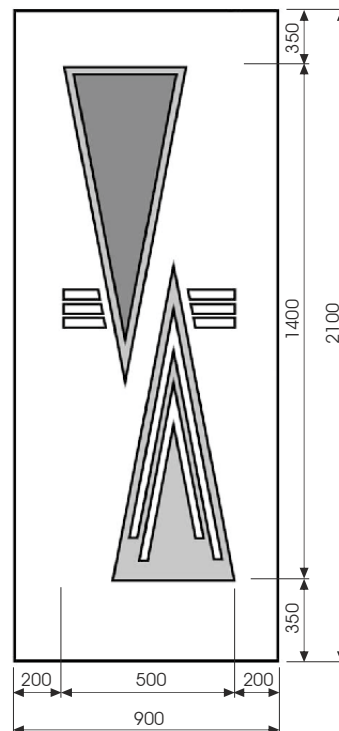



ULTRA

HPL • AL



DV-187

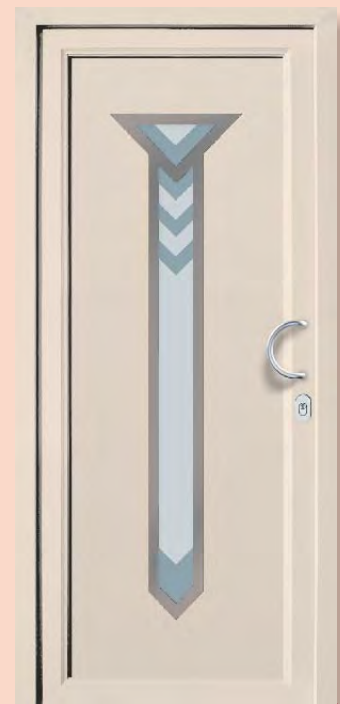
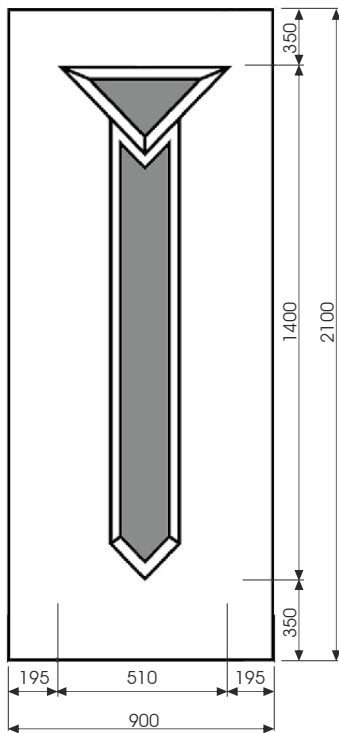

DV-187 GL187P1



DV-203



DV-203 GL203P1

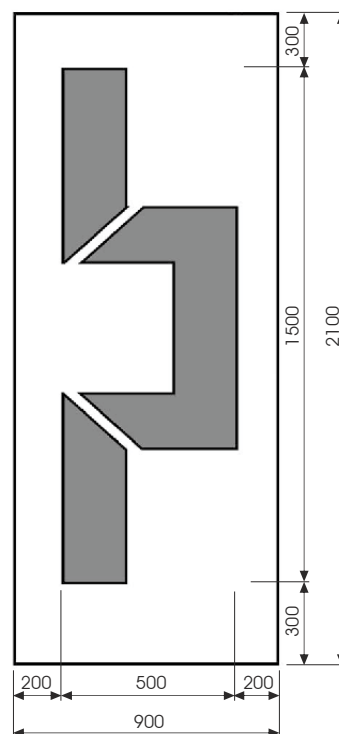



DV-204 GL204V2



DV-204

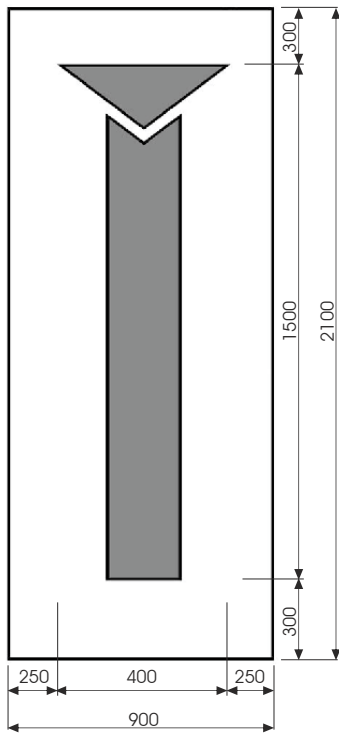

DV-204

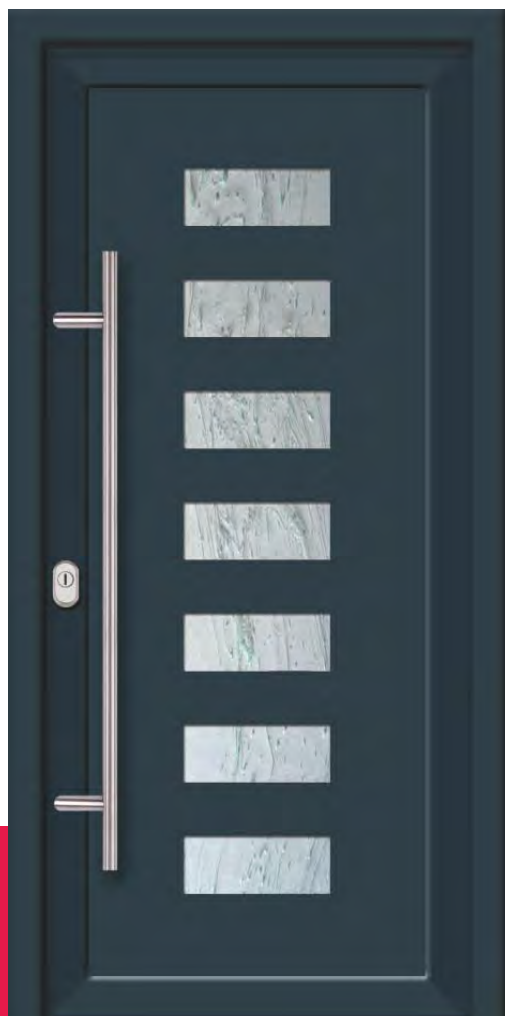

DV-205



DV-205 GL205P1



DV-205

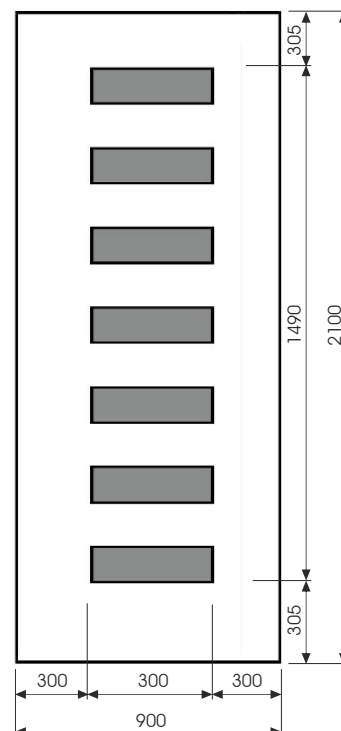



ULTRA

HPL • AL



DV-206 GL206V1



DV-206

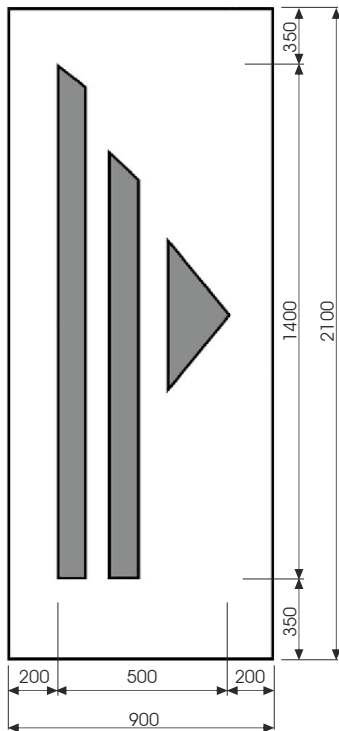

DV-206 GL206P1



DV-207 GL207V2



DV-207



DV-207 GL207V1



DV-207 GL207V3

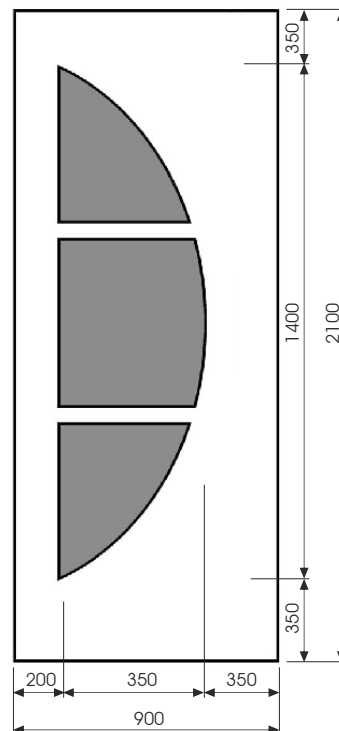



DV-208 GL208V1



DV-208

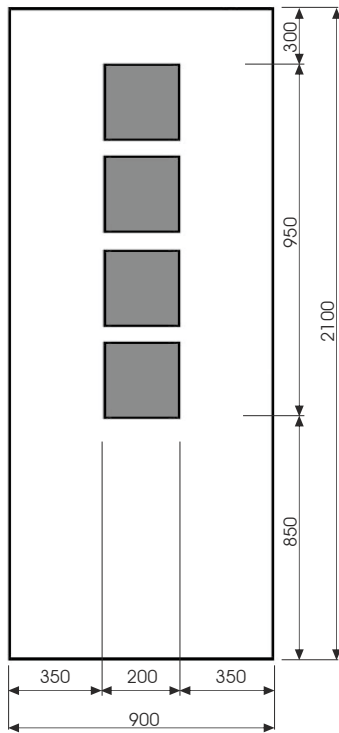

DV-208



DV-209 GL209V2



DV-209



DVF-209 D

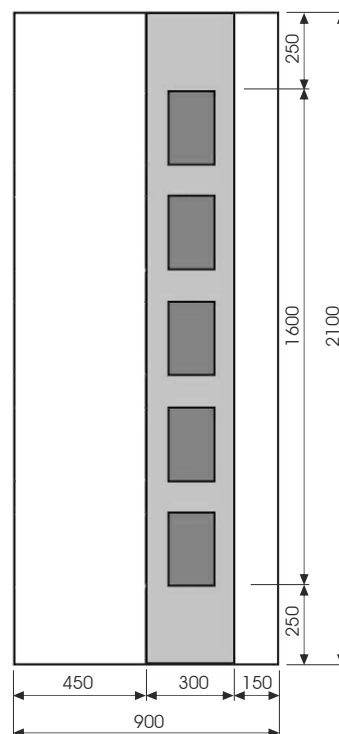



DV-211 GL211P1



DV-211

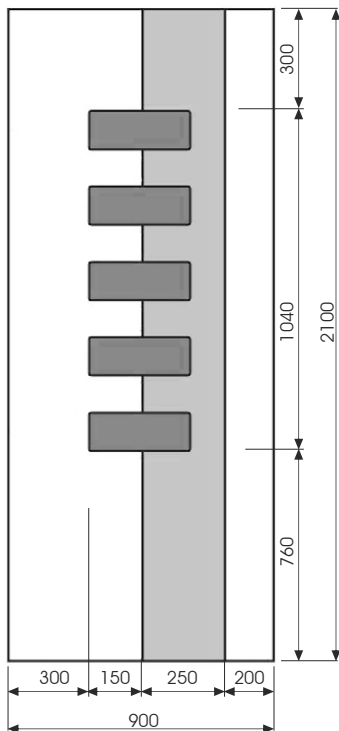

DVF-211 D



DVF-214 D



DV-214



DV-214 GL214V1

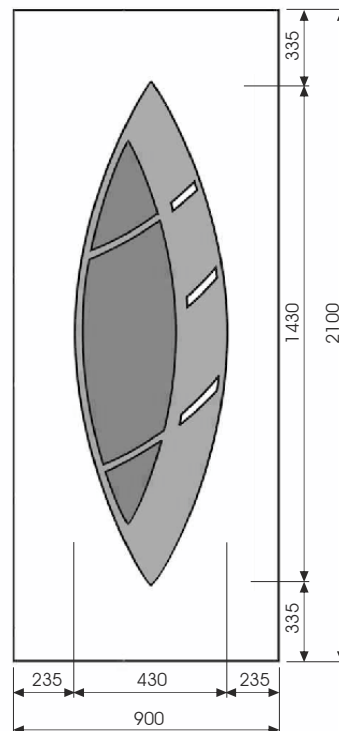



ULTRA

HPL • AL



DV-215

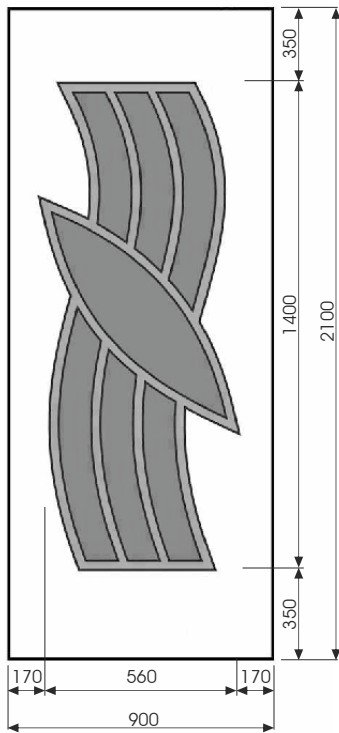

DV-215 GL215V2

BK-20



DV-214 GL214V1



DV-216



DV-216 GL216P1



DVF-216 D

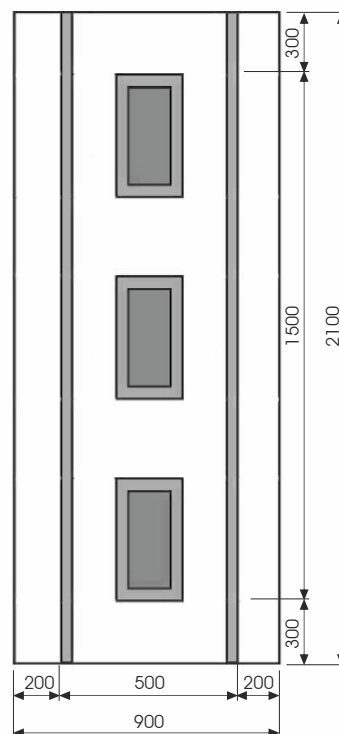



DV-219

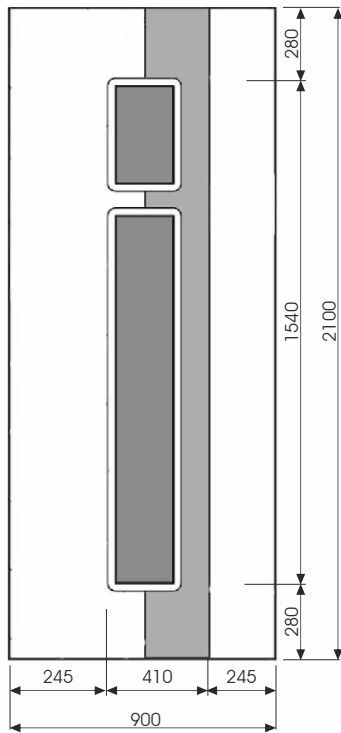

DVF-219 D



DV-219 GL219P1



DV-220



DV-220 GL220P1

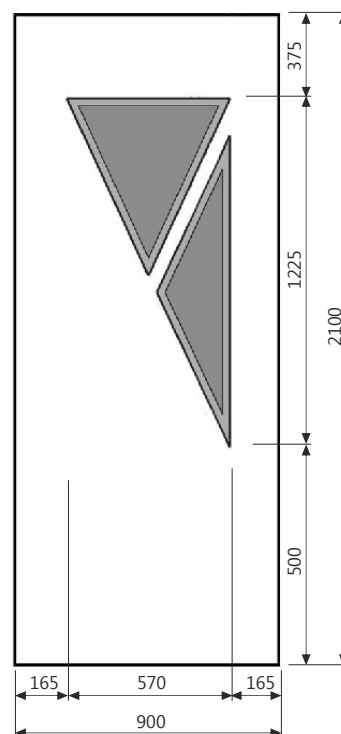



DV-222 GL222V1

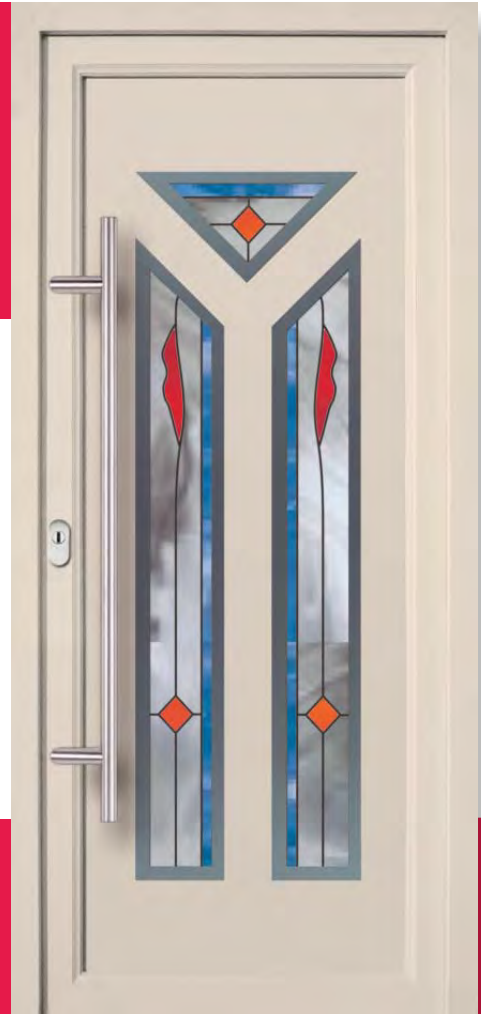

DV-222

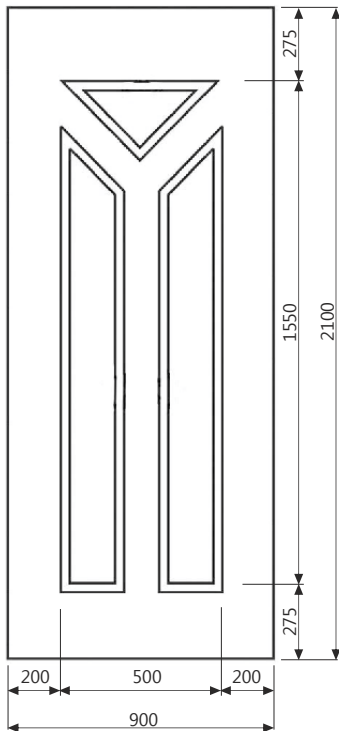

DV-222



DV-224 GL224V2



DV-224



DV-224

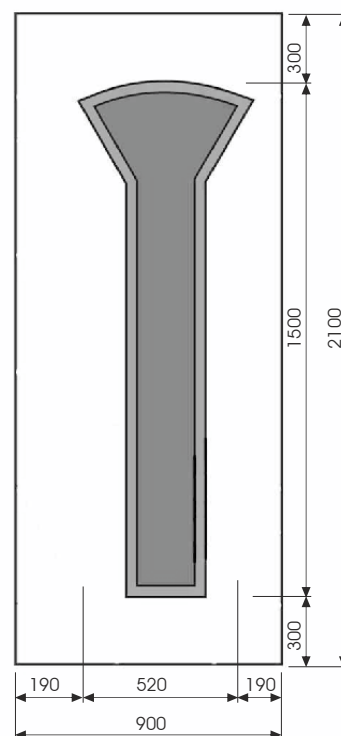



ULTRA

HPL • AL



DV-226

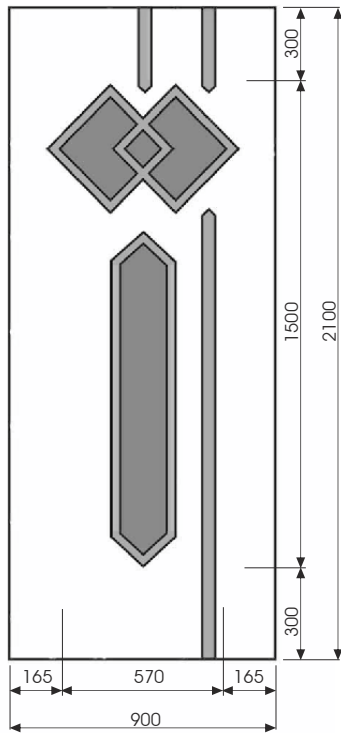

DV-226 GL226V2



DV-229 GL229V2



DV-229



DV-229

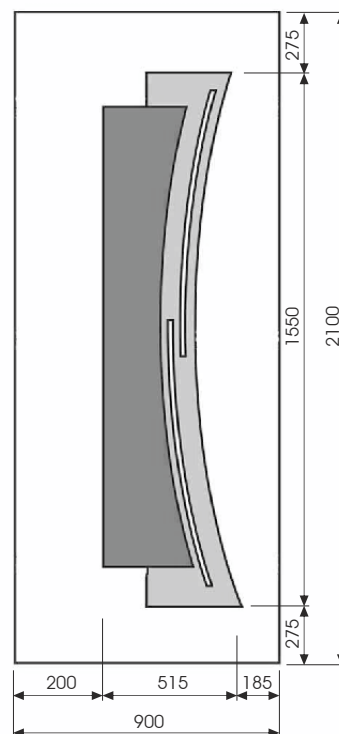



DV-230 GL230V2

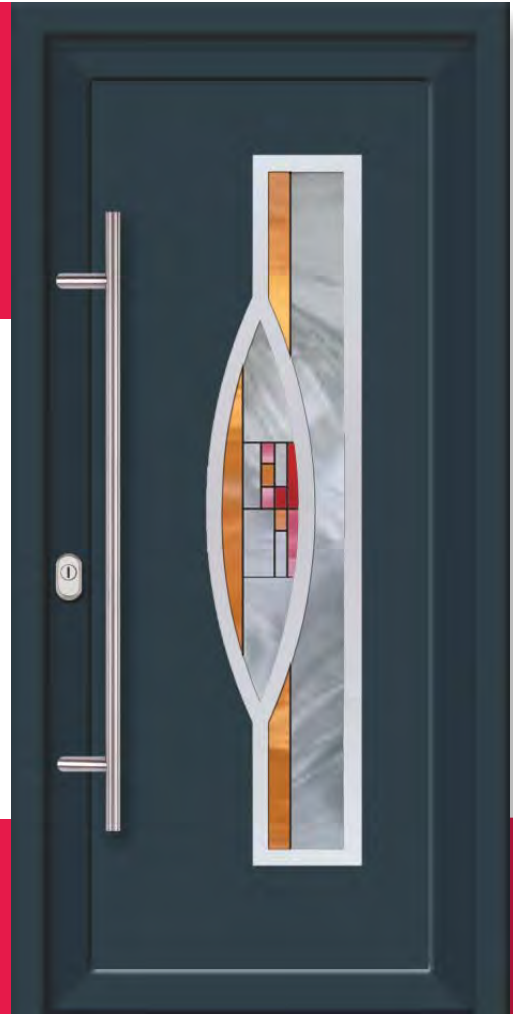

DV-230

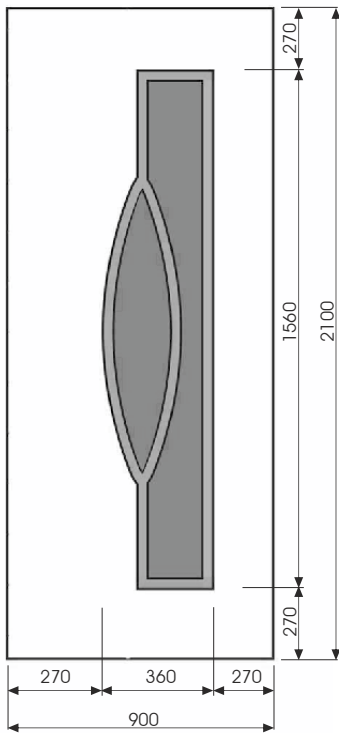

DV-230



DV-232 GL232V1



DV-232



DV-231



DV-232 GL232V2

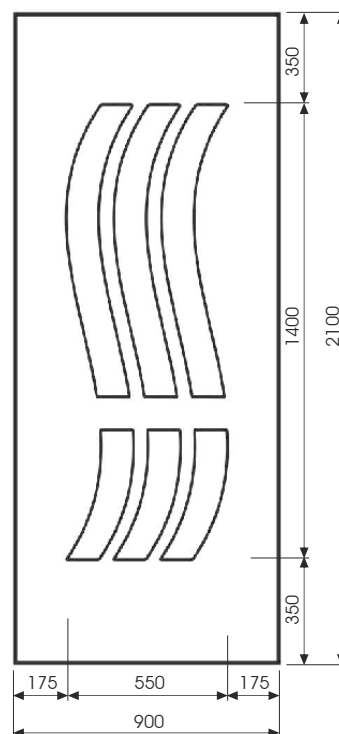



DVF-234 D

DV-233 GL233V2

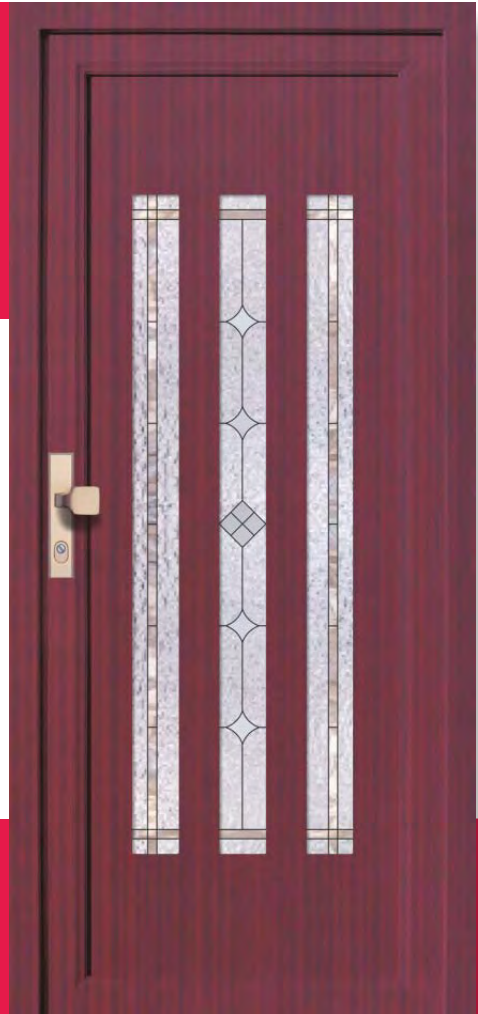

DV-233

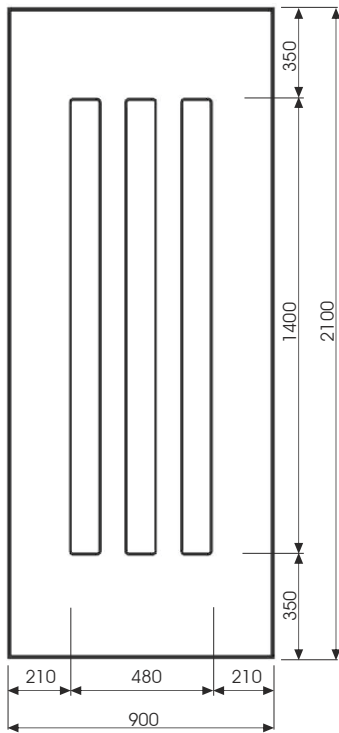

DV-234



DV-233 GL233V1



DV-235 GL235V2



DV-235



DV-235 GL235V1



DV-236

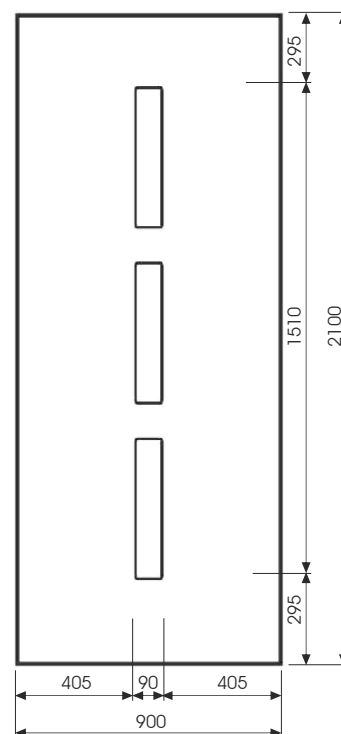



DV-239 GL239V2



DV-239 GL239V1

DV-239

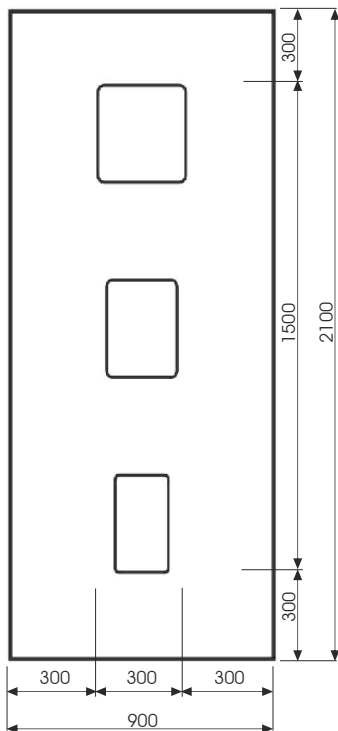

DV-237



DV-238



DV-239 GL239V3



DV-240



DV-241

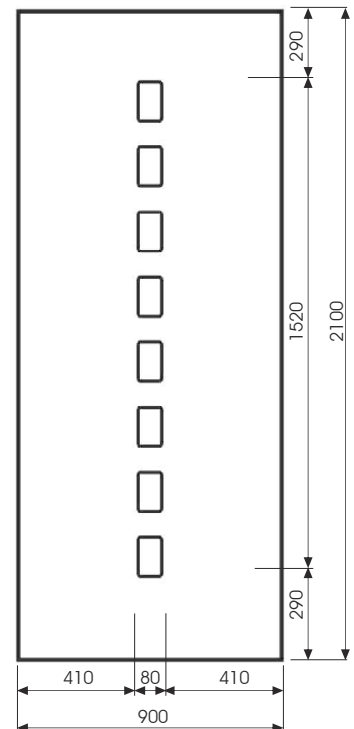



DVF-243 D



DV-242

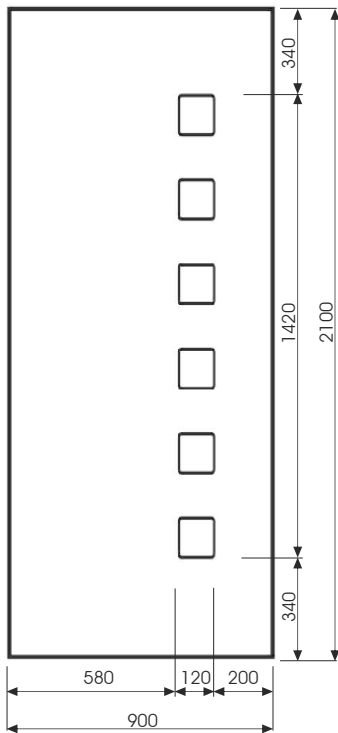

DV-243

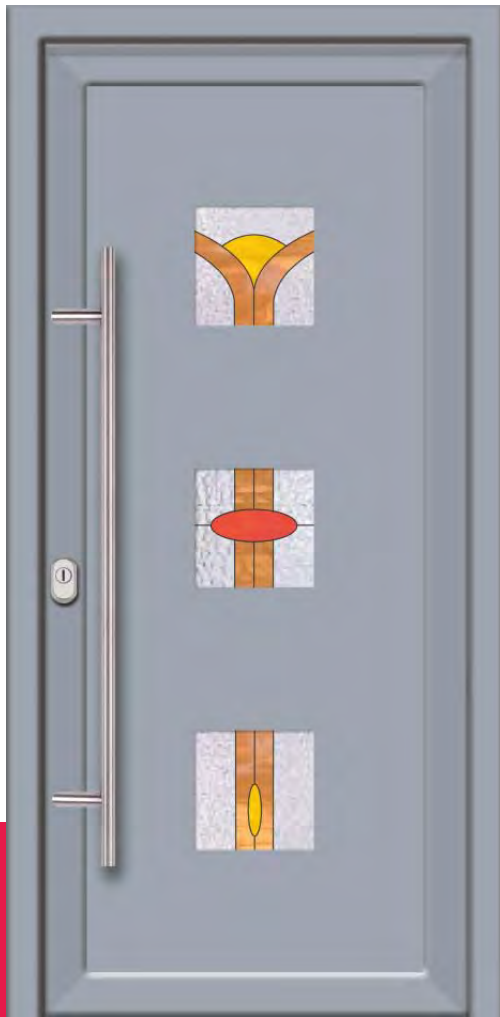

DV-244 GL244V2

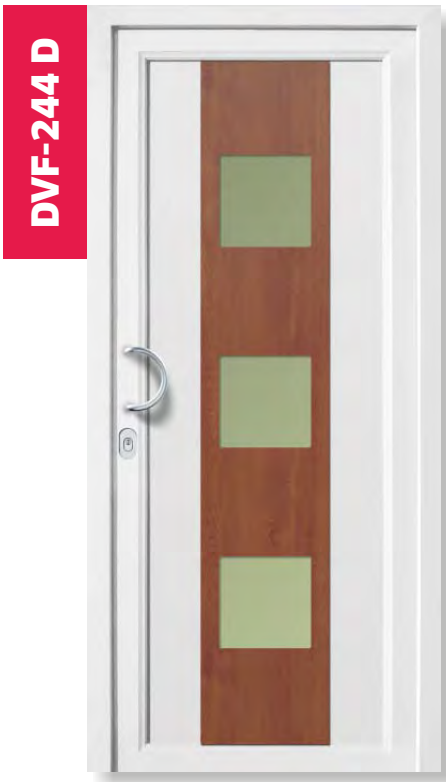

DVF-244 D

DV-244



DV-244 GL244V1



DV-244 GL244V3



DV-244

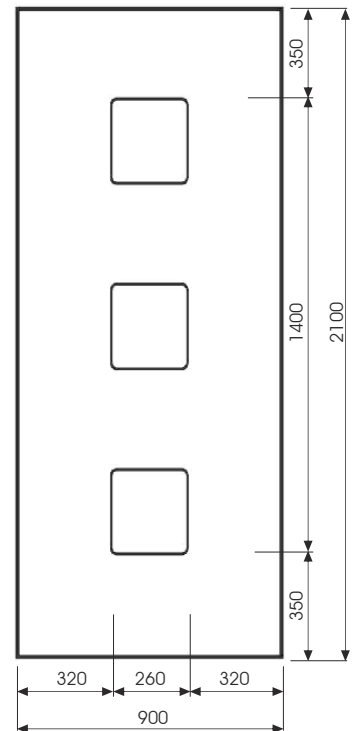



DV-247 GL247V1

BK-17



DV-246

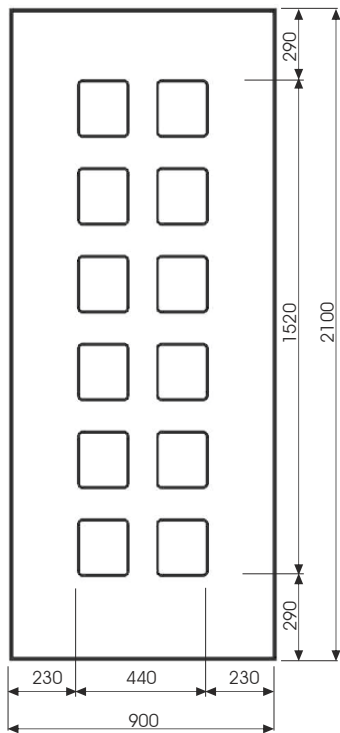

DV-245



DV-247 GL247V2



DV-248

DV-249



DV-250



DV-251

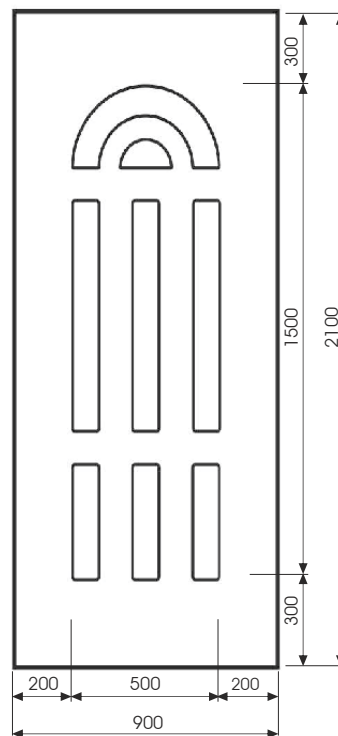



DV-252

DV-254 GL254V2



DV-254

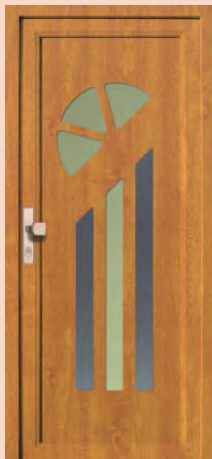
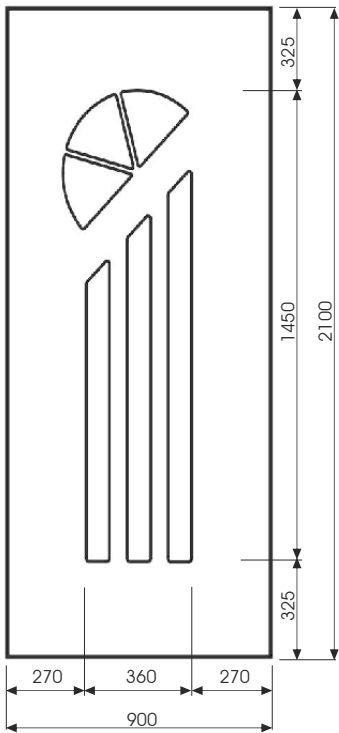

DV-253

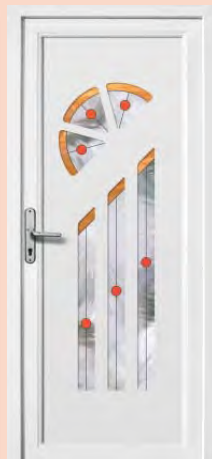

DV-254 GL254V1



DV-254 GL254V3



DV-256 GL256V2

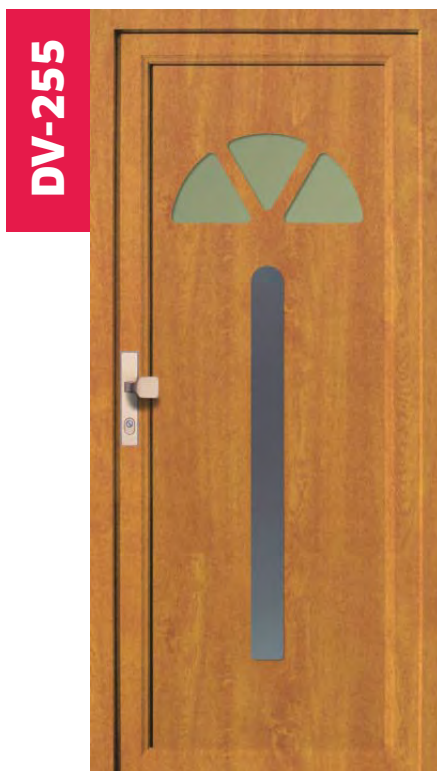

DV-255

DV-256



DV-256 GL256V1



DV-256 GL256V3

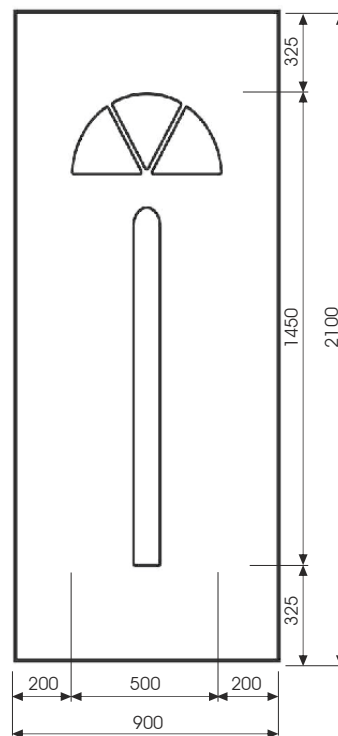



DV-257

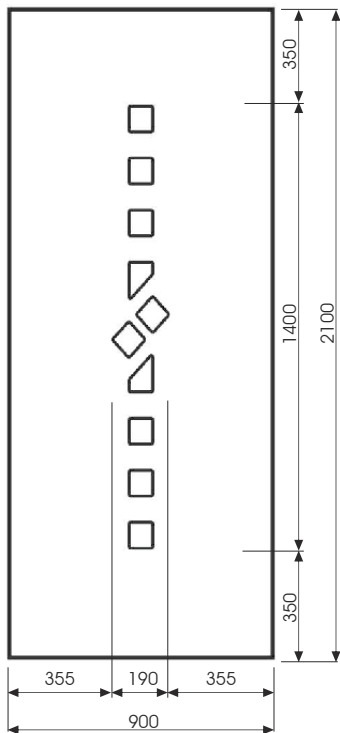

DV-257s



DV-259 GL259V3



DV-258

DV-259



DV-259 GL259V1



DV-259 GL259V2

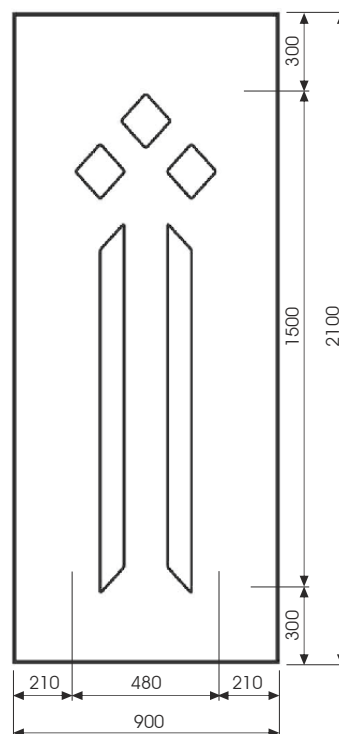



DV-260

DV-261 GL261V2

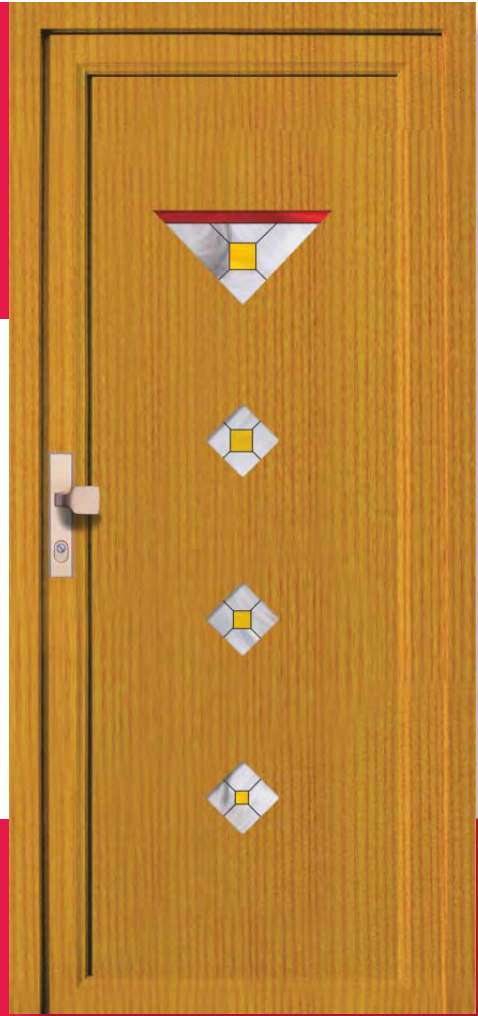

DV-261

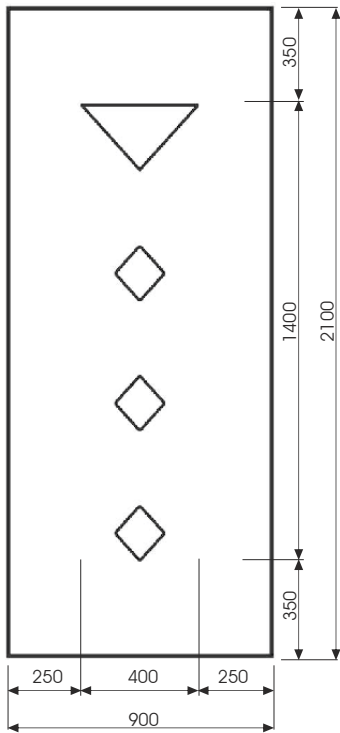

DV-261 GL261V1



DV-263 GL263V1



DV-262

DV-263



DVF-263 D



DVF-263 D GL263V2

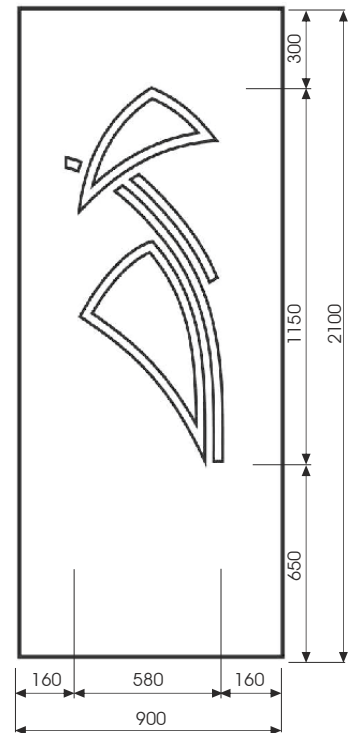



DV-264 GL264V2

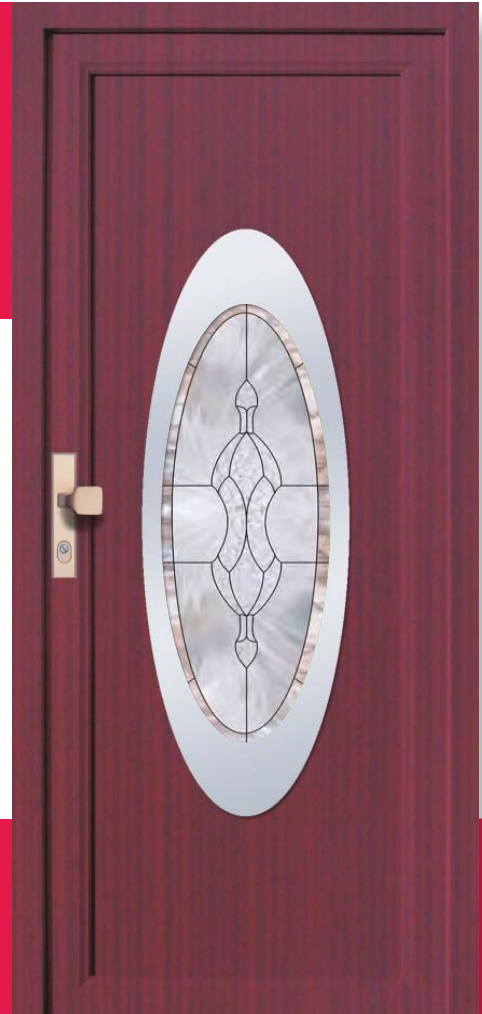

DV-264 GL264V1

DV-264

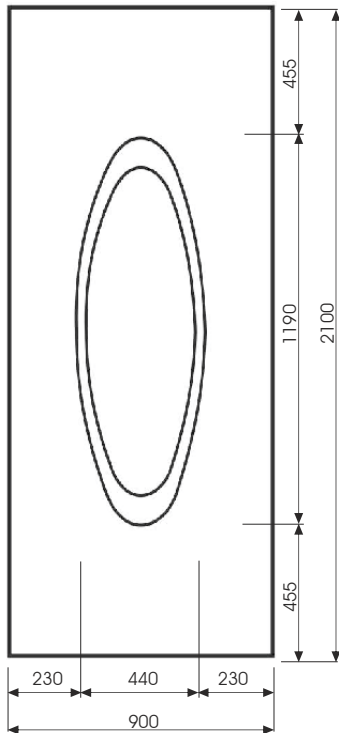

DV-264 GL264V3



DV-264 GL264V4



DV-264 GL264V5

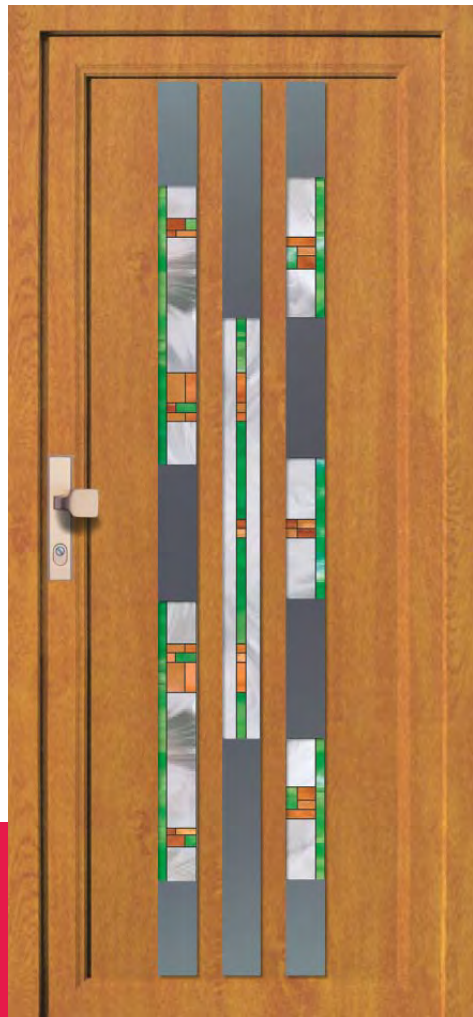

DV-265 GL265V2



DV-265



DV-265

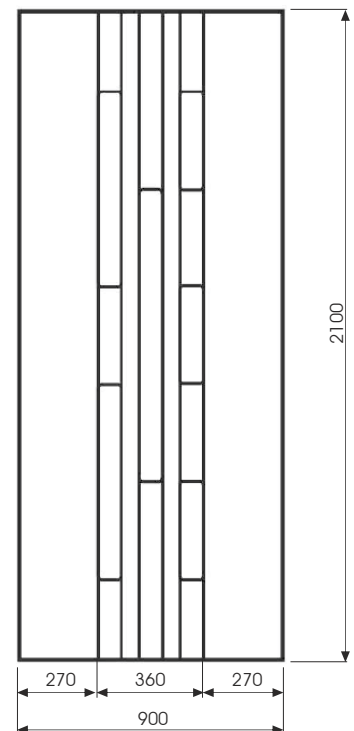



DV-270 GL270V2



DV-270 GL270V1

DV-270



DV-268



DV-269

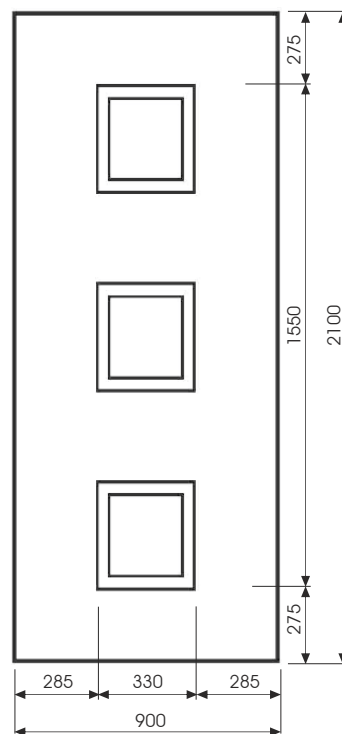



DV-273 GL273V1

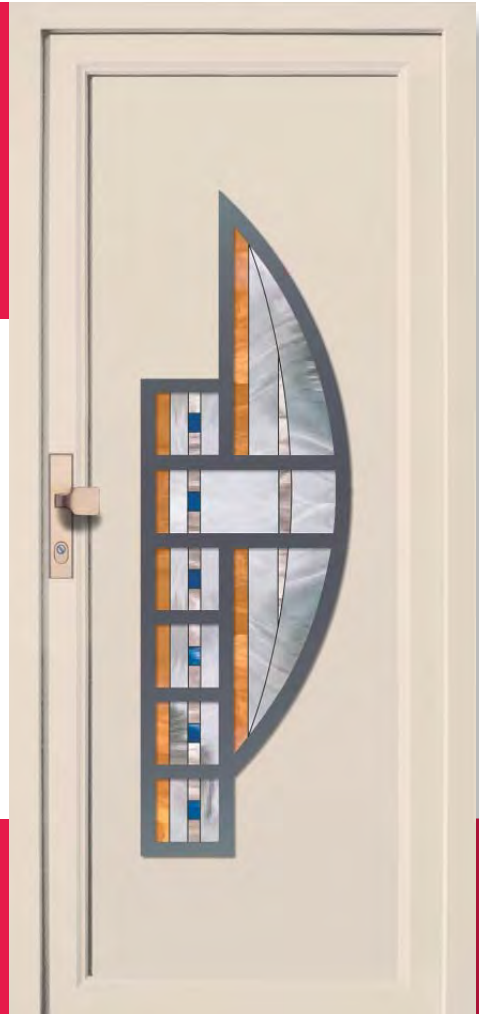

DV-273 GL273V2

DV-273

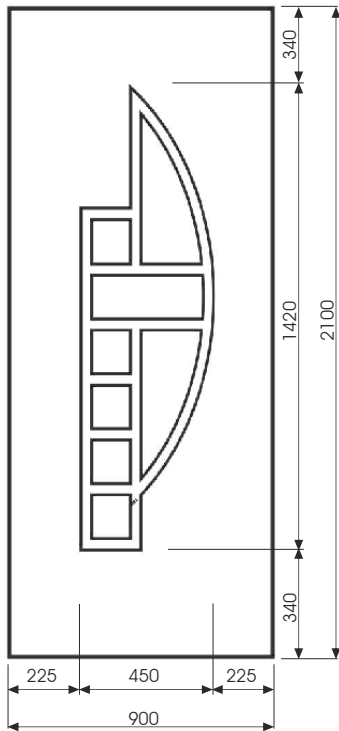

DV-271



DV-272

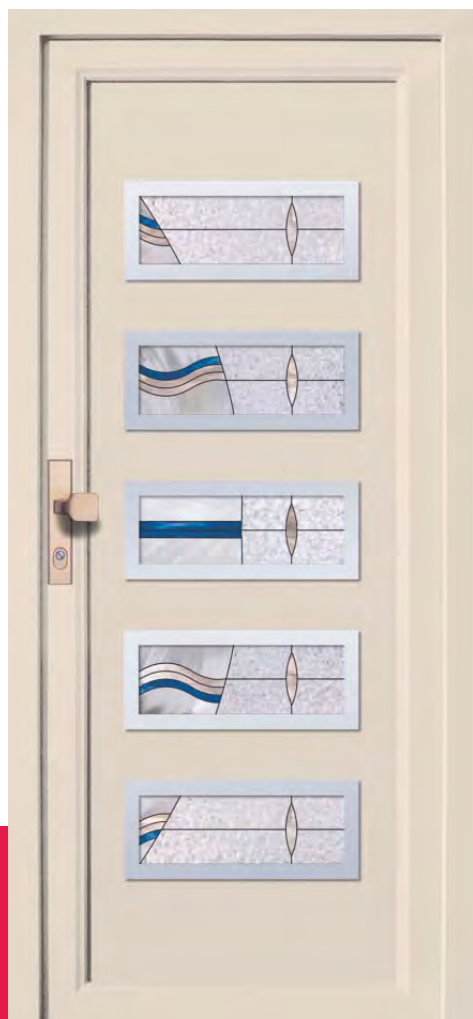

DV-275 GL275V2



DV-274

DV-275

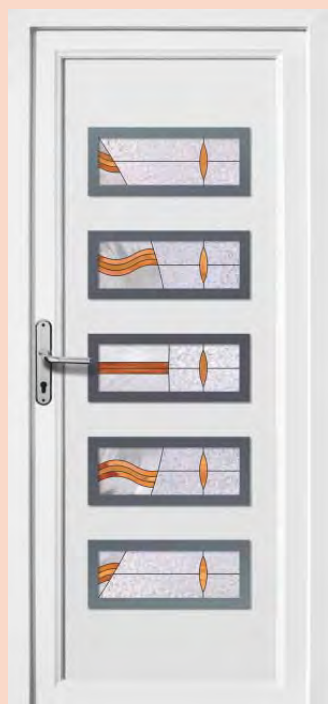

DV-275 GL275V1

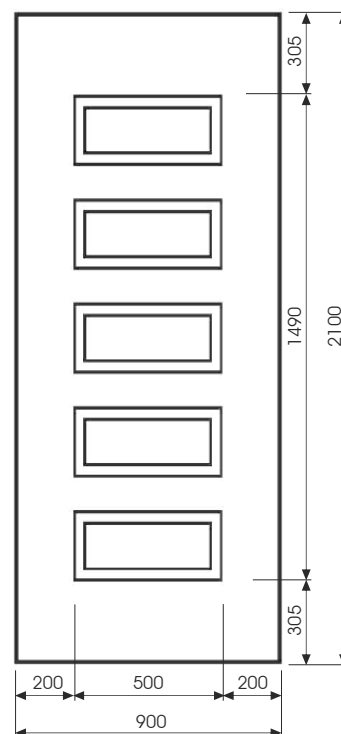



DV-276

DV-277 GL277V2



DV-277

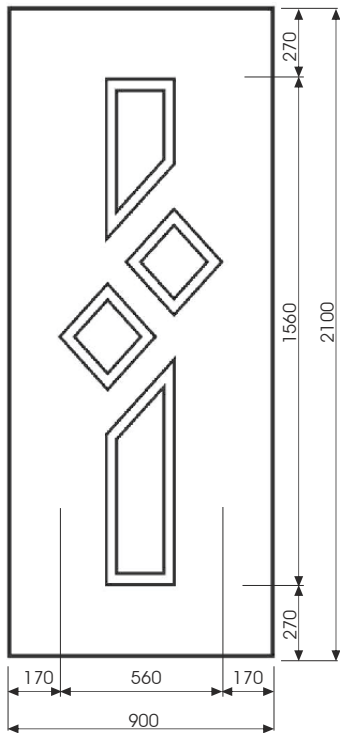

DV-277 GL277V1

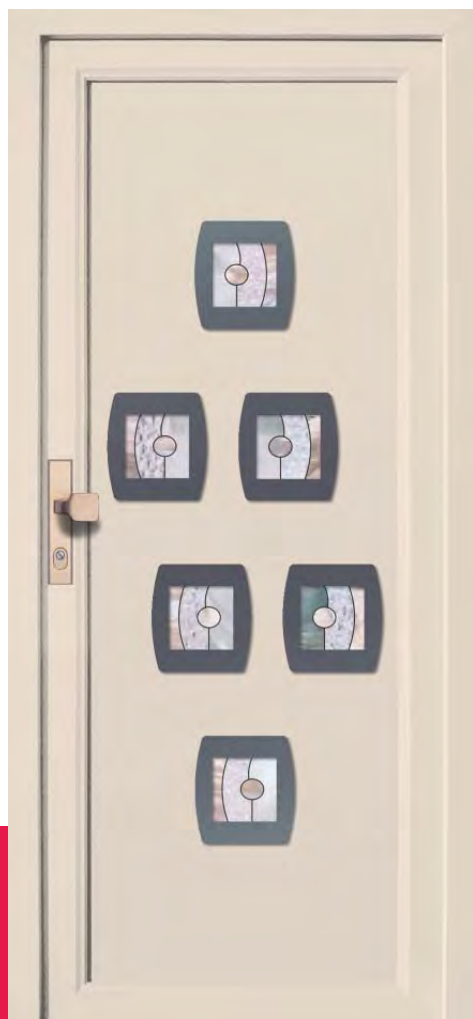

DV-279 GL279V1



DV-278

DV-279

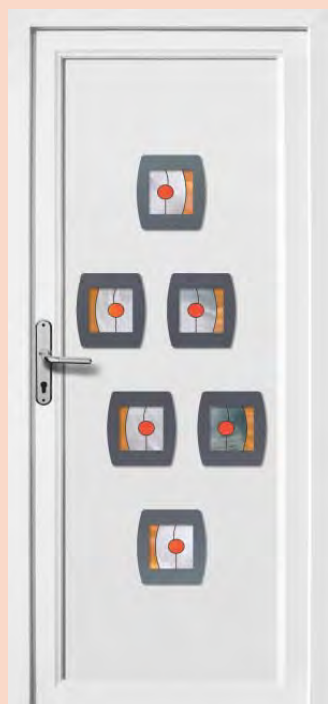

DV-279 GL279V2



DV-279 GL279V3

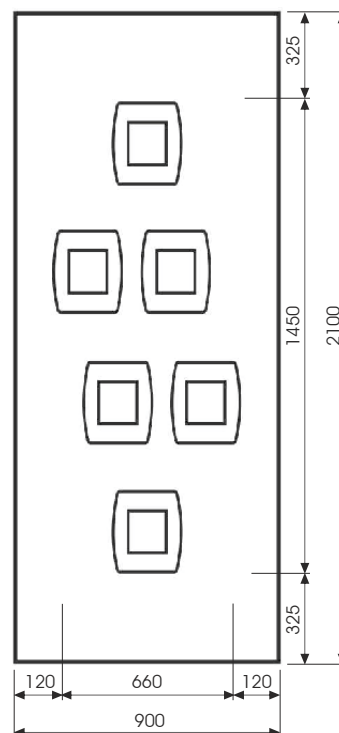



DV-282 GL282V2



DV-282 GL282V1

DV-282

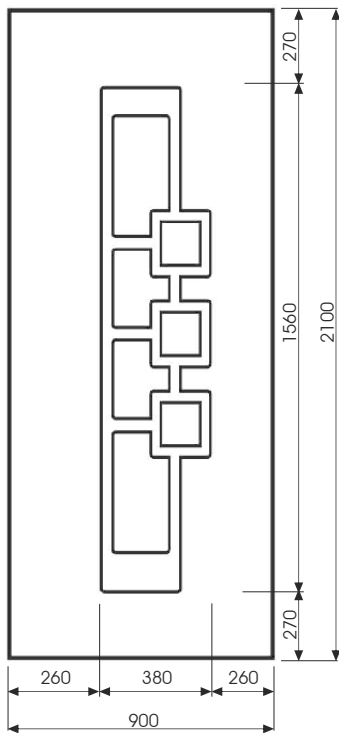

DV-280



DV-281

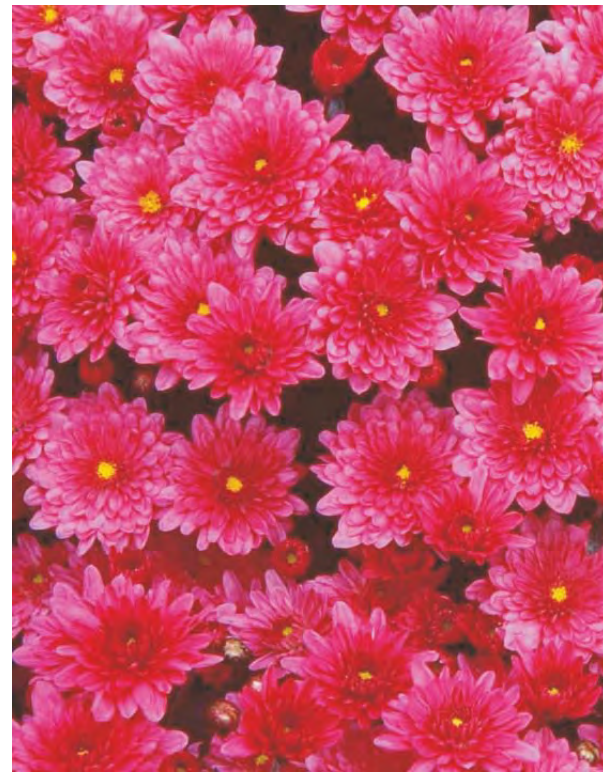

DV-284



DV-283

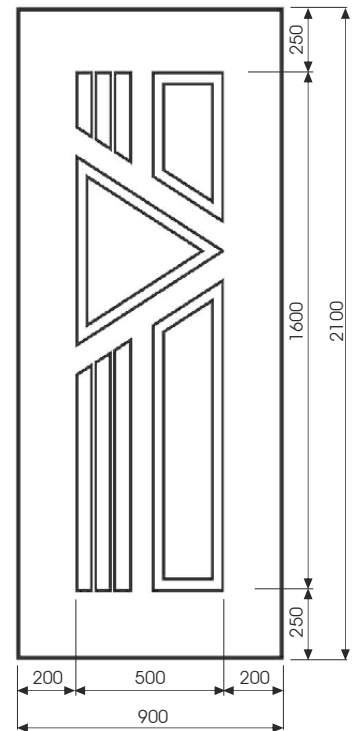



DV-285

DV-286 GL286V3



DV-286

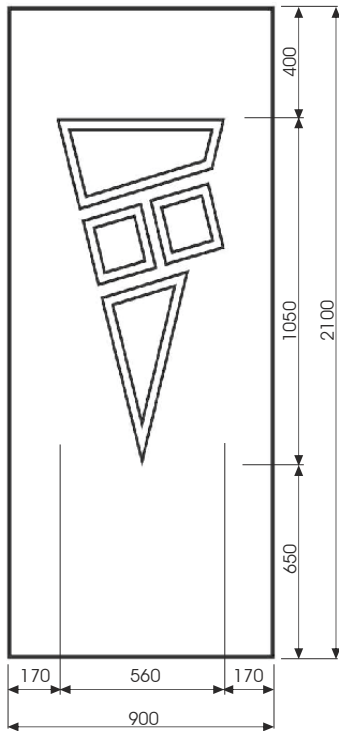

DV-286 GL286V1



DV-286 GL286V2

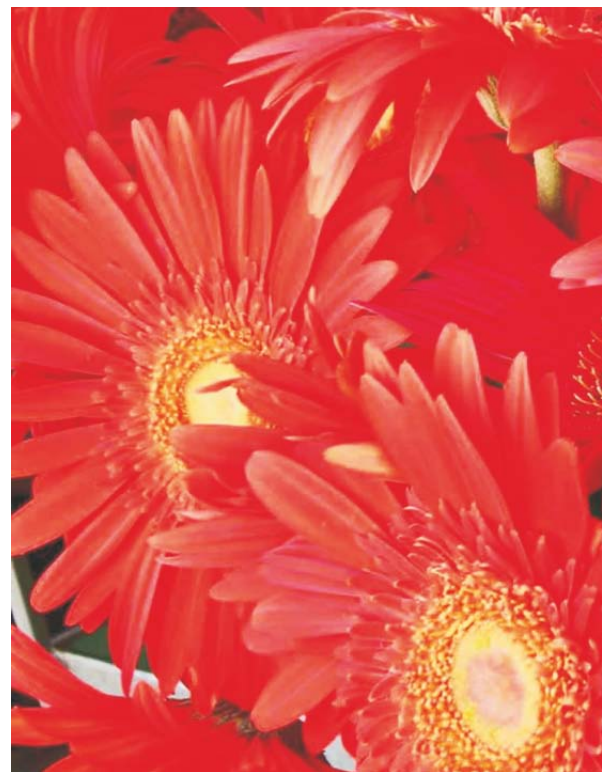

DV-287



DV-288

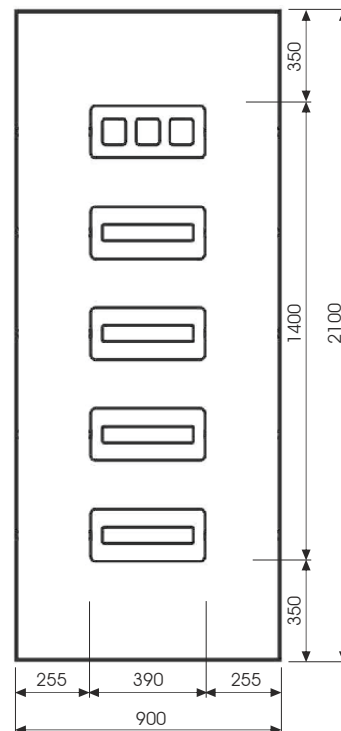



DV-291

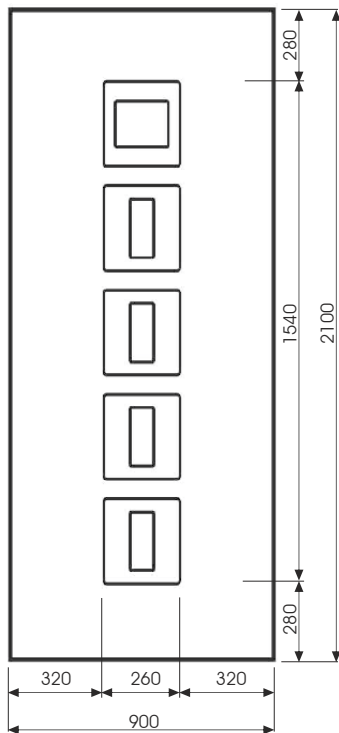

DV-290



DV-293 GL293V1



DV-292

DV-293



DV-293 GL293V3

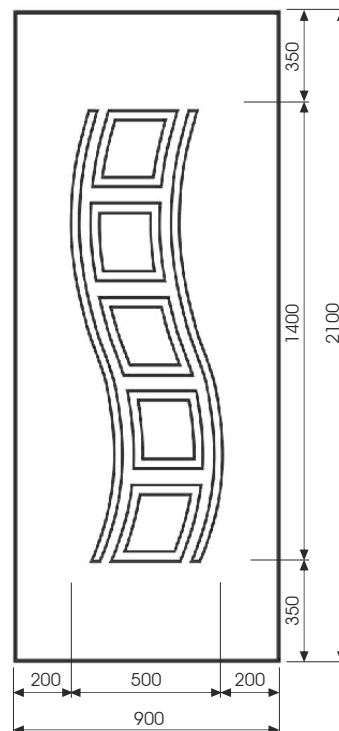



DV-421

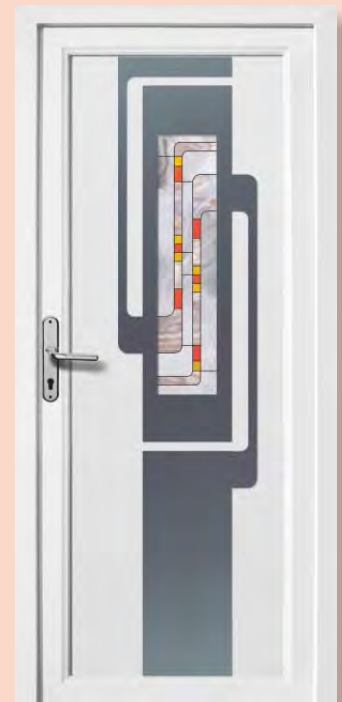
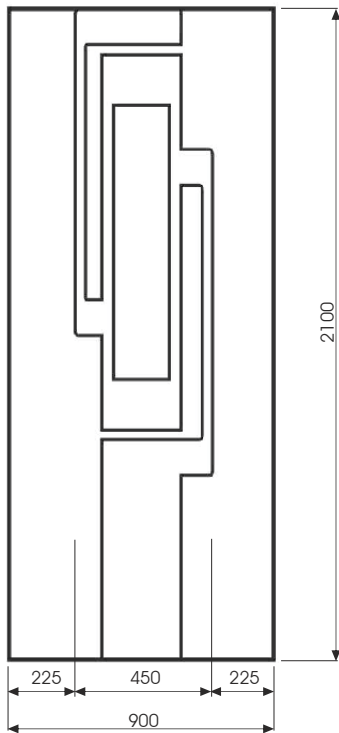

DV-421 GL421V1



DV-422 GL422V1



DV-422



DV-422

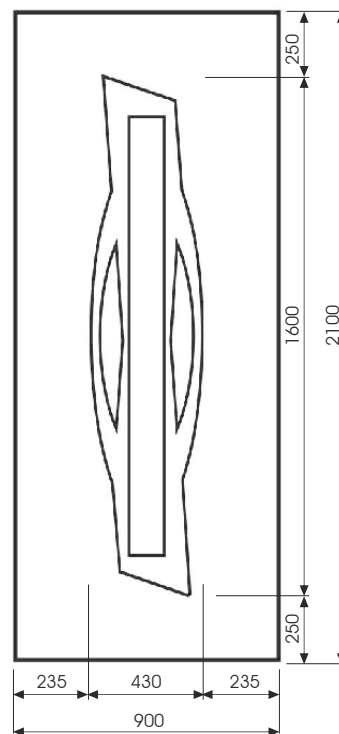



ULTRA

HPL • AL



DV-424

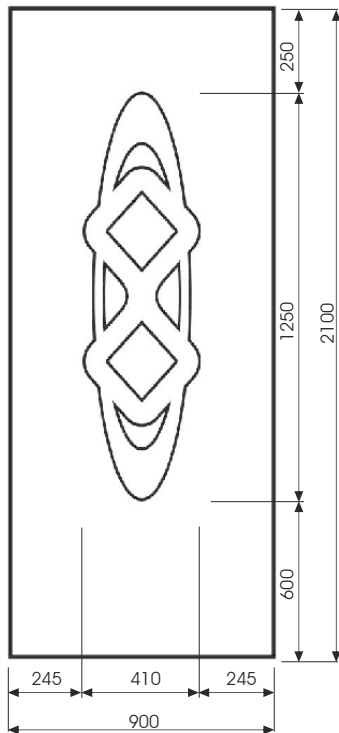

DV-423



DV-425 GL425V1



DV-425



DV-425

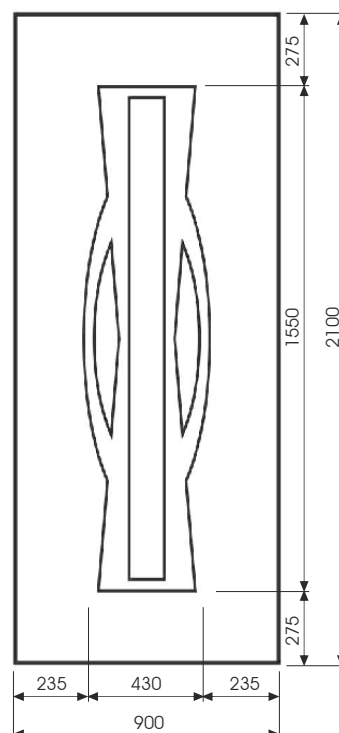



DV-426 GL426V1



DV-426

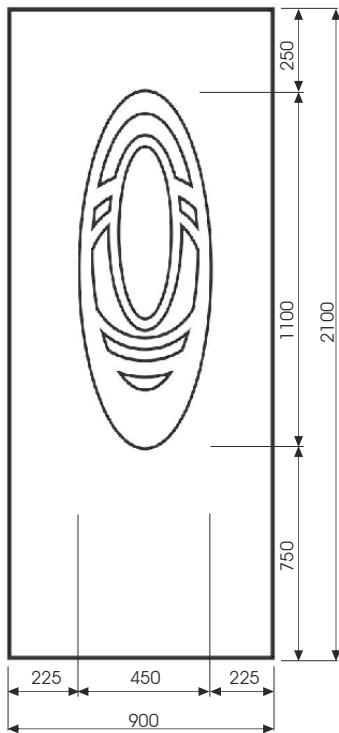

DV-426

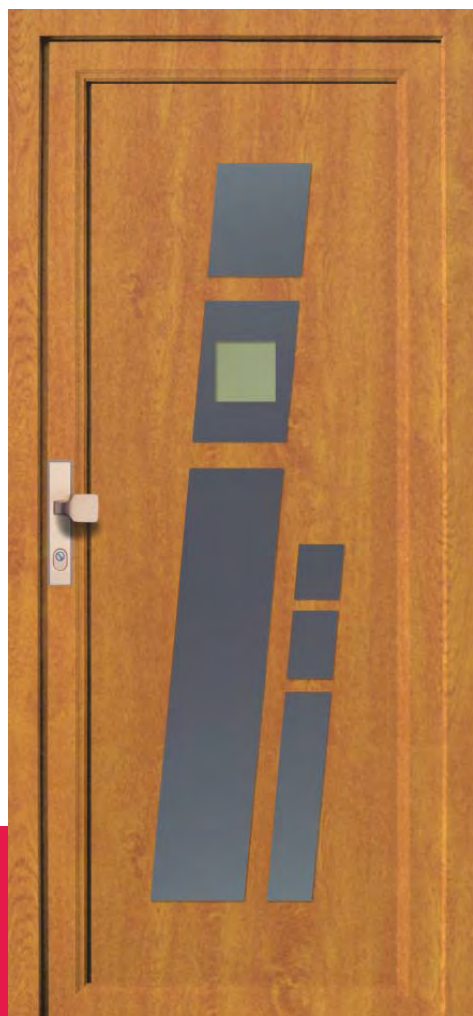

DV-427

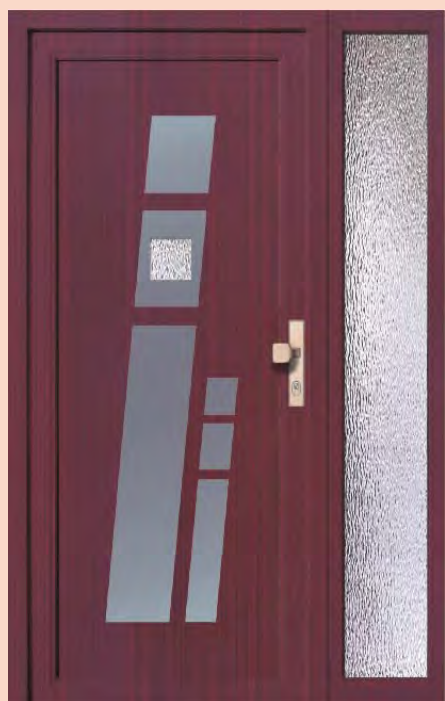

DV-427s

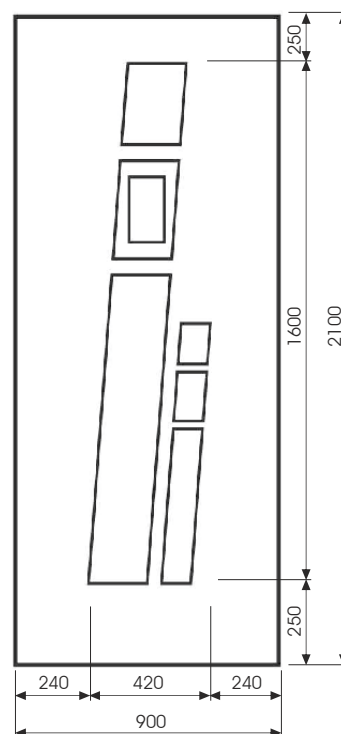



ULTRA

HPL • AL



DV-428

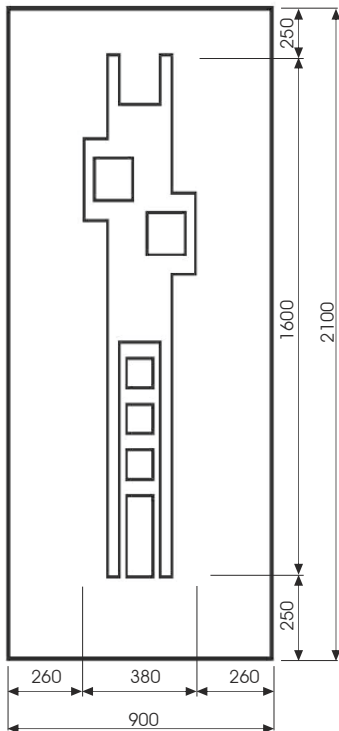

DV-428 GL428P1



DV-429 GL429V1



DV-429



DV-429

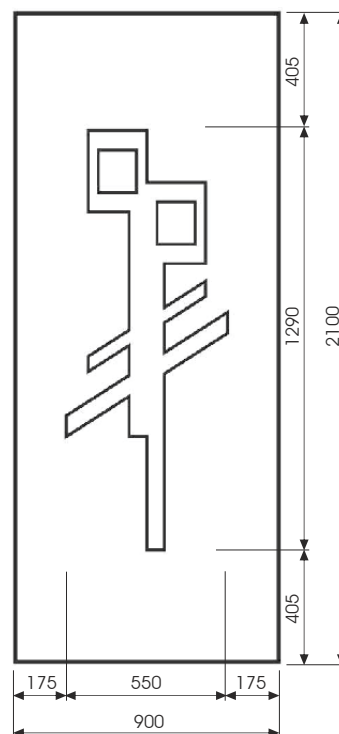



ULTRA

HPL • AL



DV-430 GL430V1



DV-430

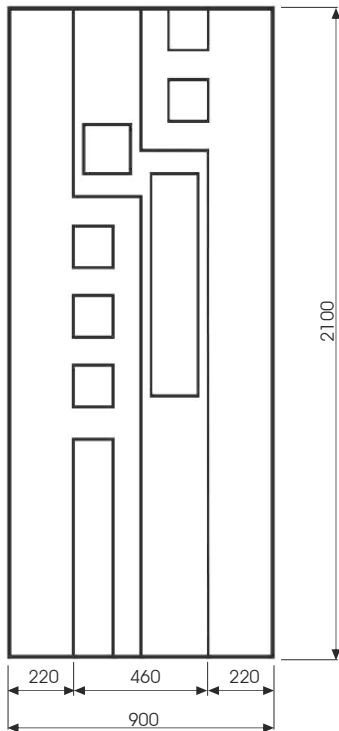

DV-430

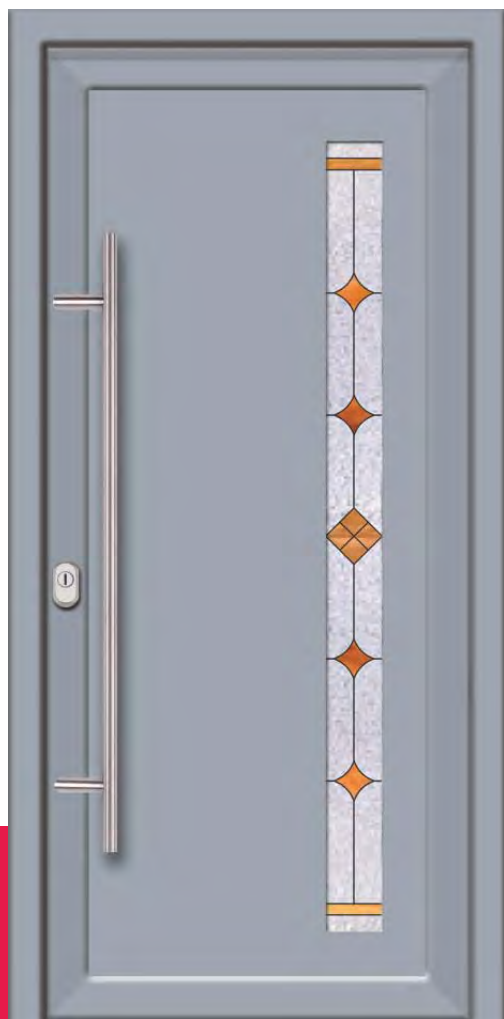

DV-431 GL431V1



DV-431



DV-431 GL431P1

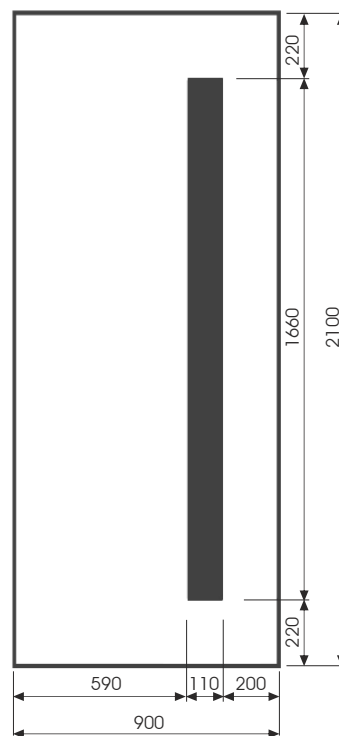



DV-432 GL432V1

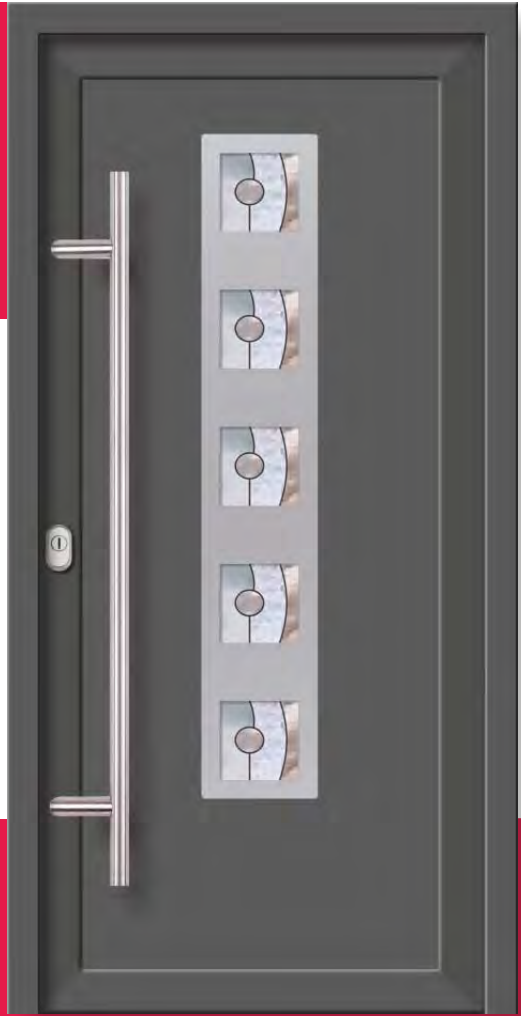

DV-432

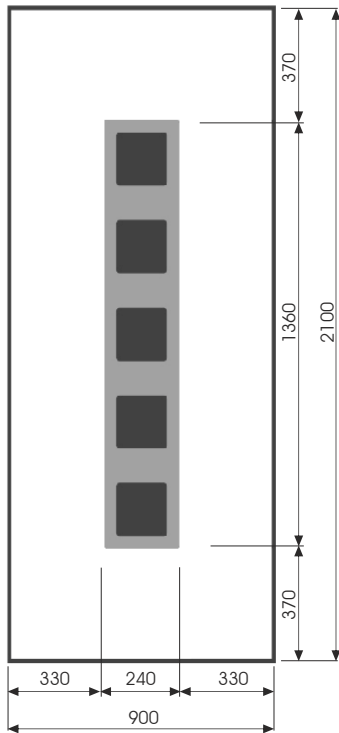

DV-432

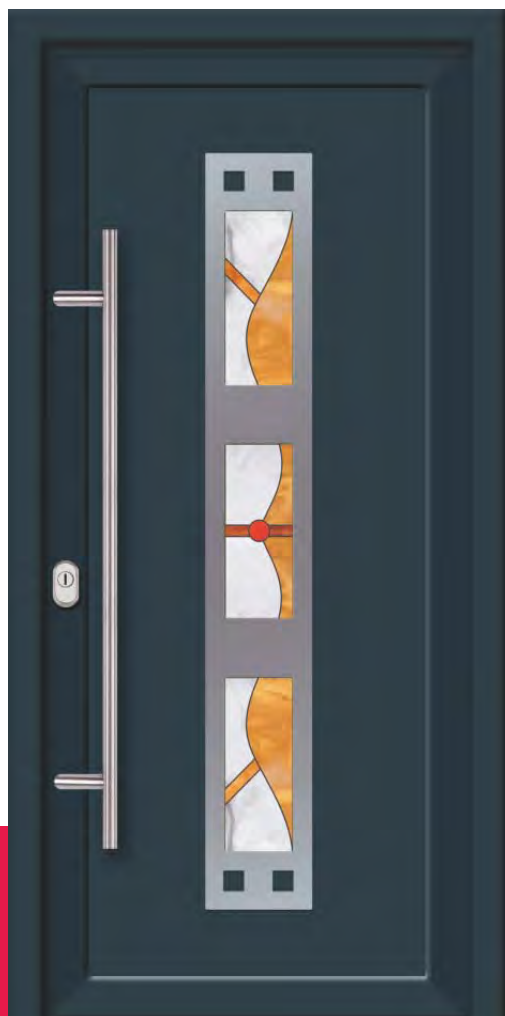

DV-433 N GL433NV1



DV-433 N



DV-433 N

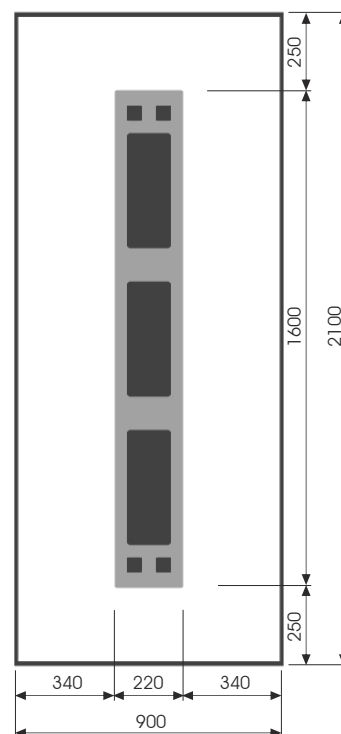



DV-434 GL434V1



DV-434

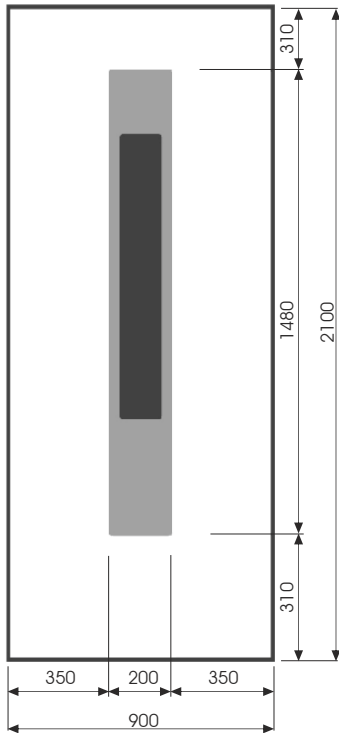

DV-434 GL434P1



DV-434



DV-435



DV-435 GL435P1

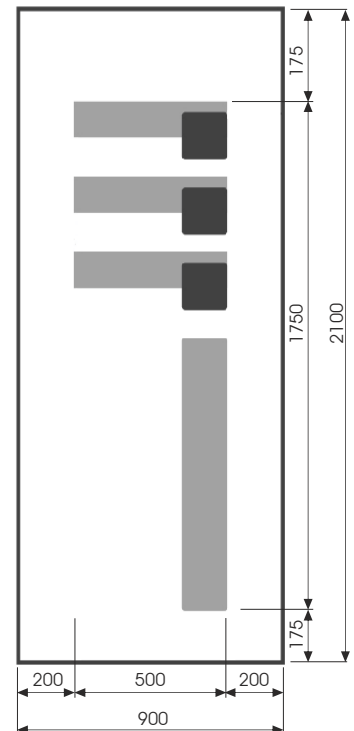



DVF-436 D GL436DV3

DV-436 N GL436NV2

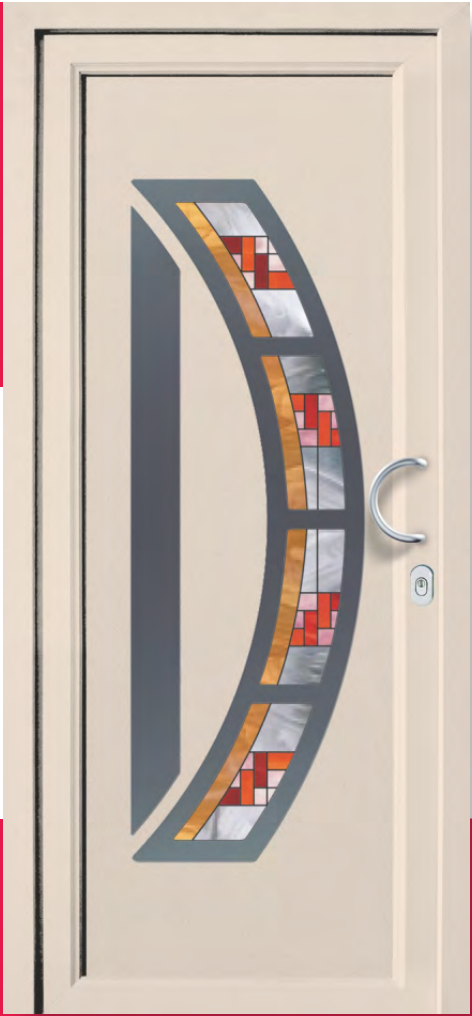

DV-436 N

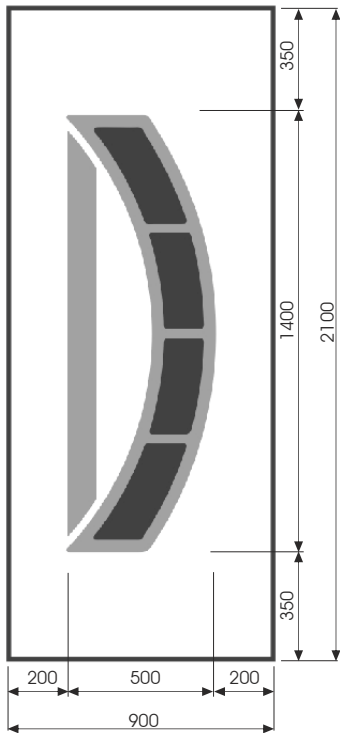

DV-436 N GL436NV1



DV-436 N GL436NV4



DV-437

DVF-438 D



DV-438

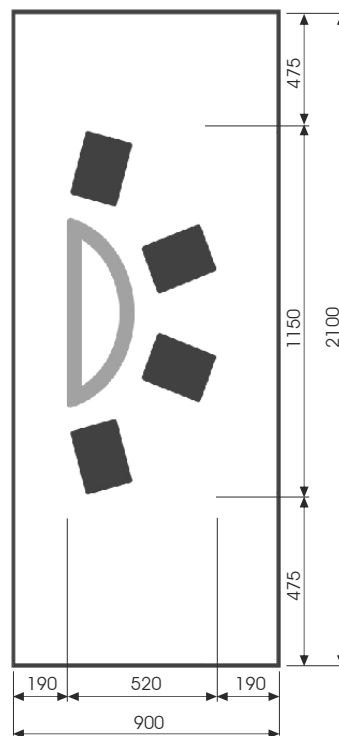



DV-440



DV-439

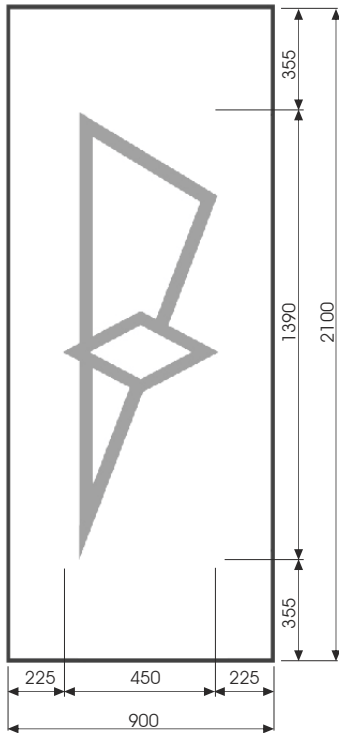

DV-442



DV-443



DV-441

SYMBOLS



HPL

AL



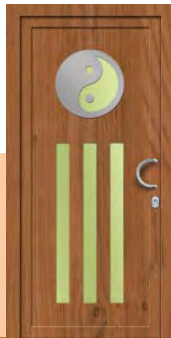

DV-600

90



DV-608

91



DV-610

92



DV-615

93

seite • page • pagina



DV-626

94



DV-630

95



DV-635

96



DV-640

97

seite • page • pagina



DV-645

98



DV-650

99

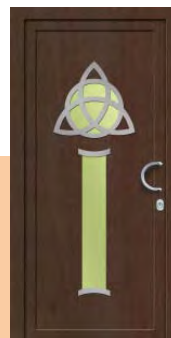

DV-655

100

seite • page • pagina



DV-600



DV-602



DV-603

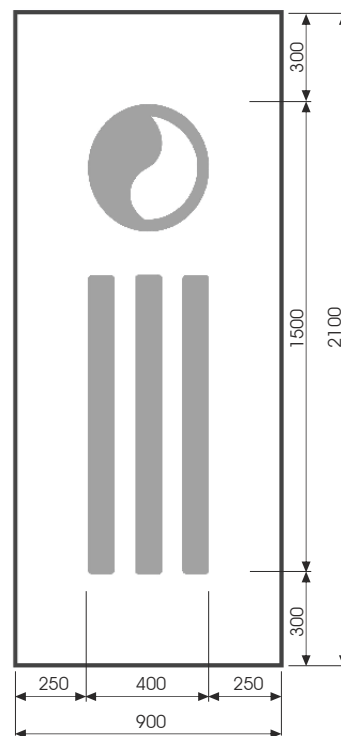



DV-605



DV-608

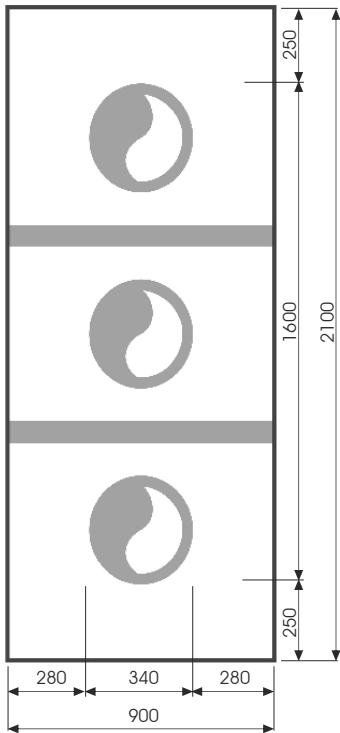

DV-606

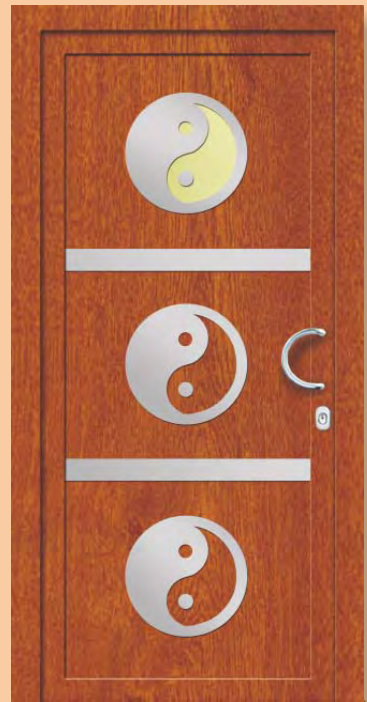

DV-607

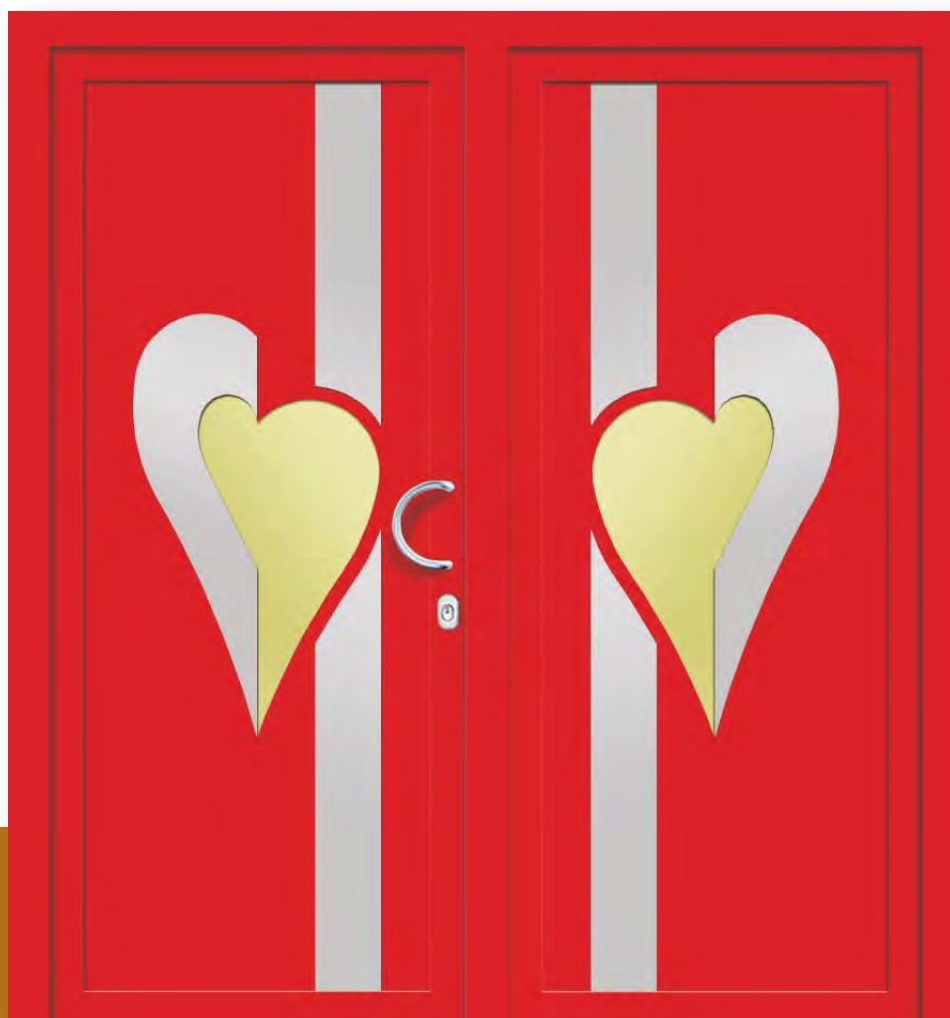

DV-610



DV-611

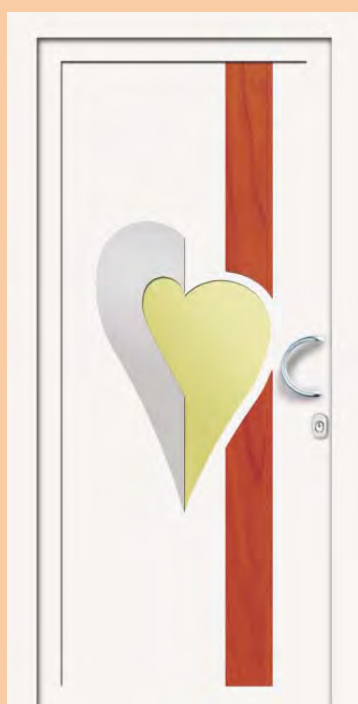

DV-612

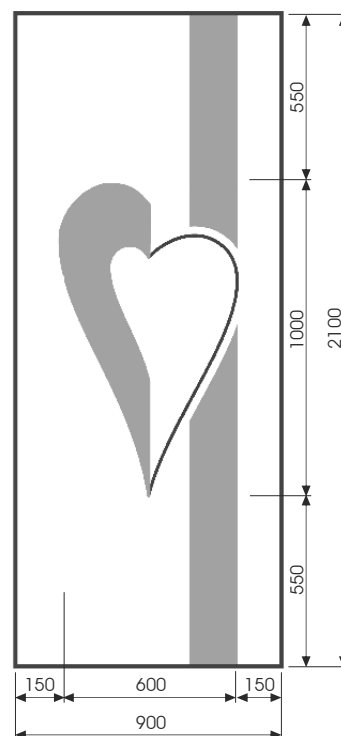



DV-615

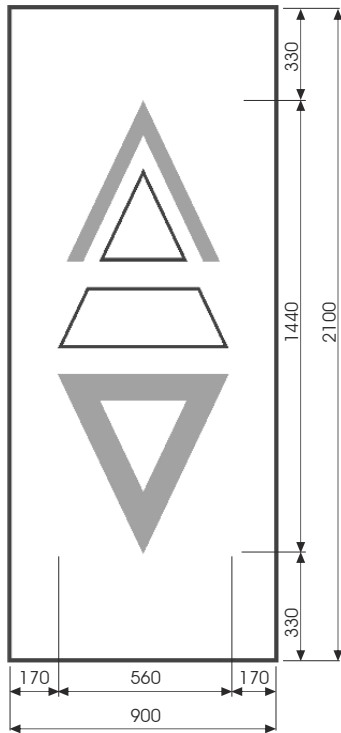

DV-616



DV-617



DV-628

DV-626



DV-625



DV-627

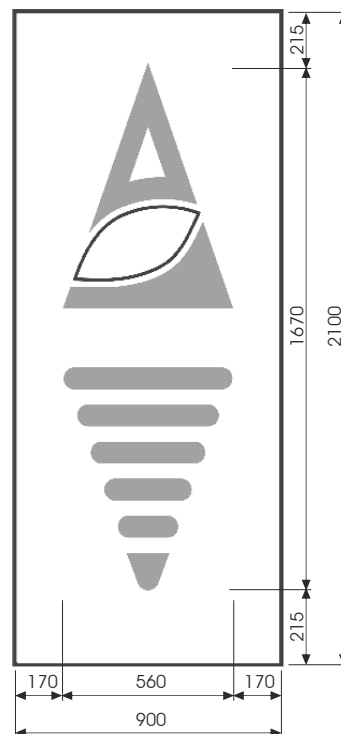



DV-630

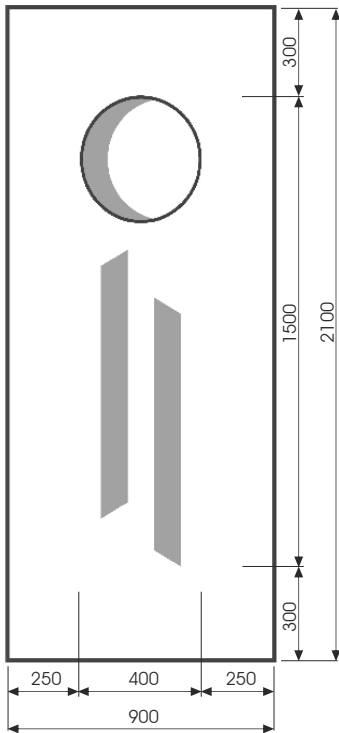

DV-631



DV-632

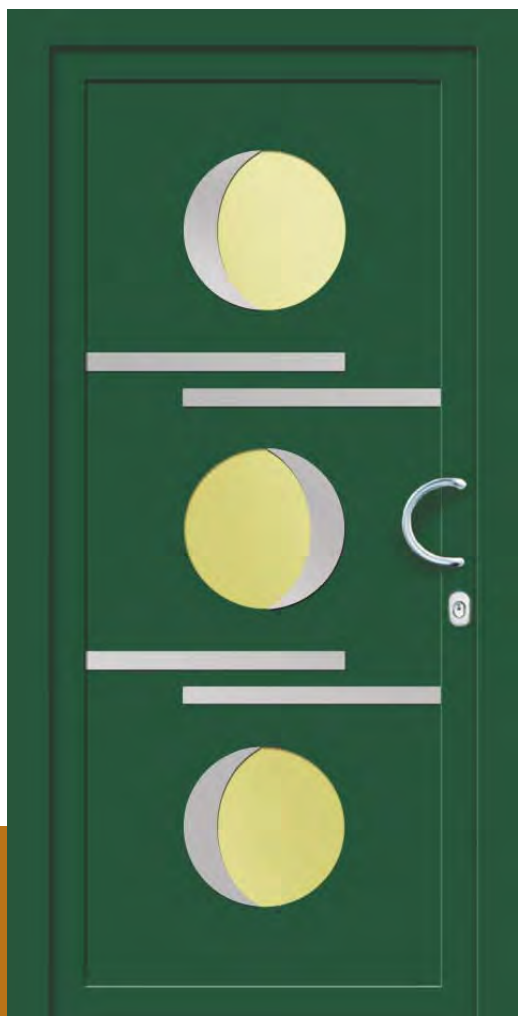

DV-635

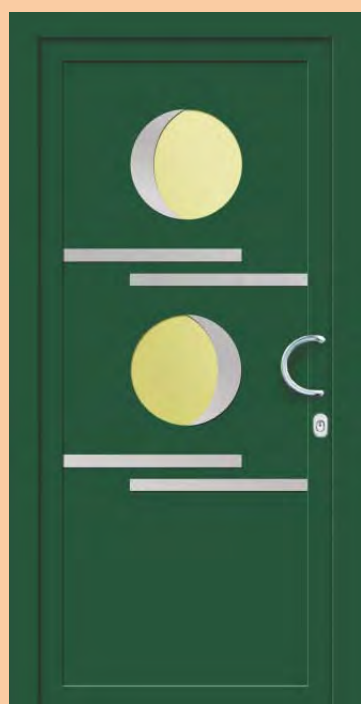

DV-636

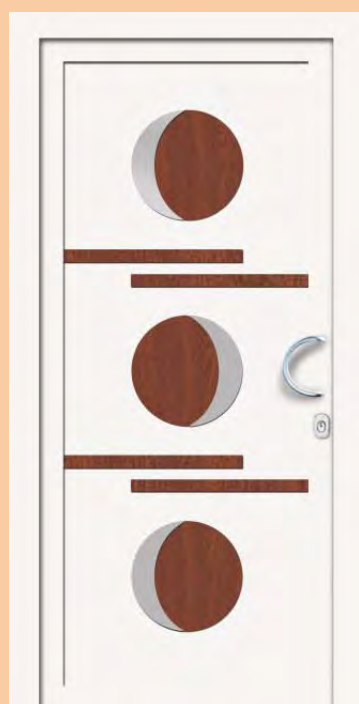

DV-638

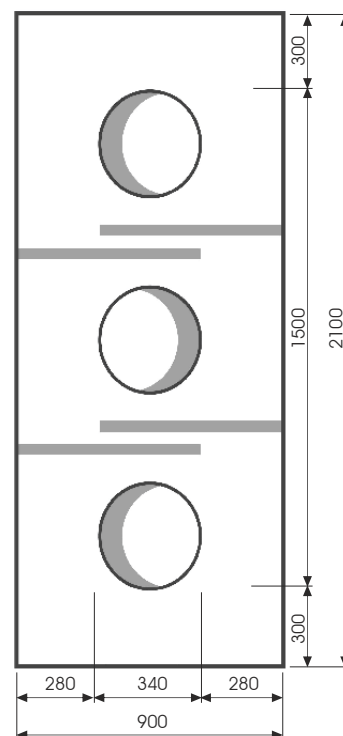



DV-641

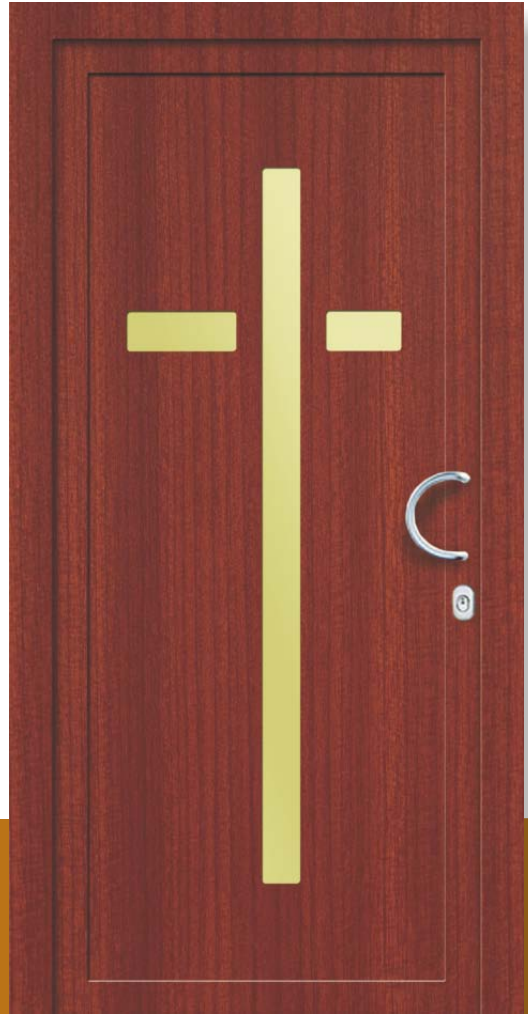

DV-640

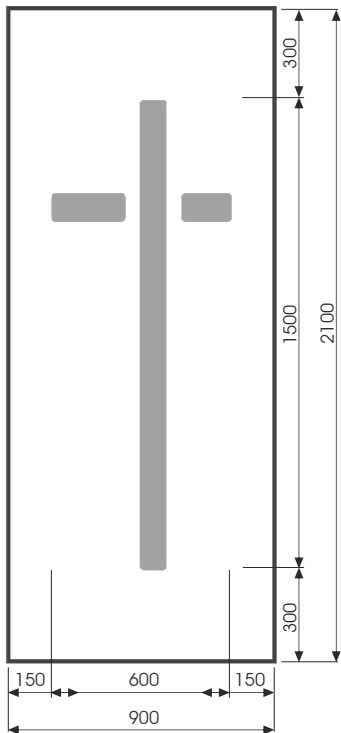

DV-642



DV-643



DV-645



DV-646



DV-647

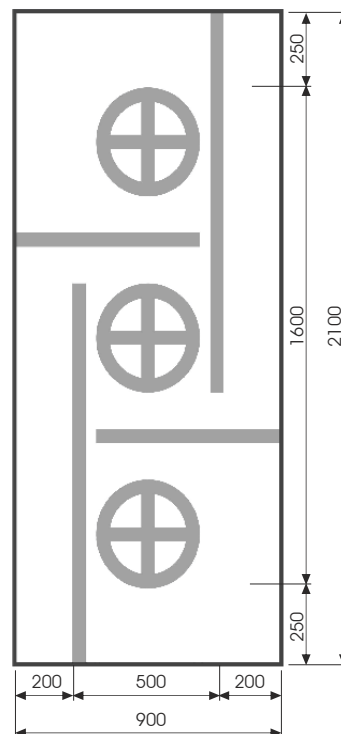



DV-641



DV-650

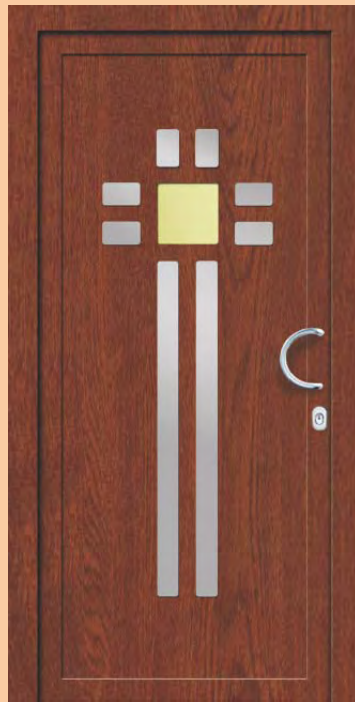
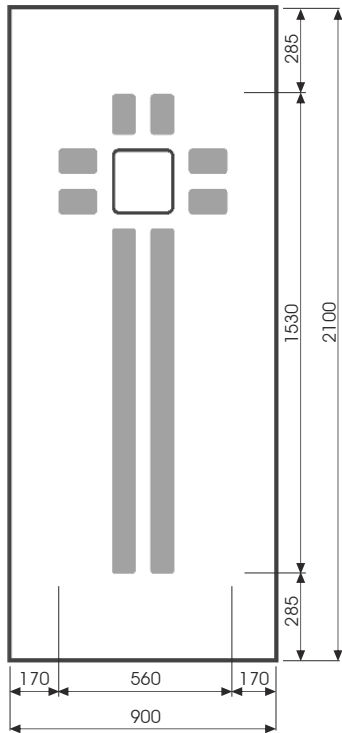

DV-651



DV-652



DV-656



DV-655



DV-657



DV-658

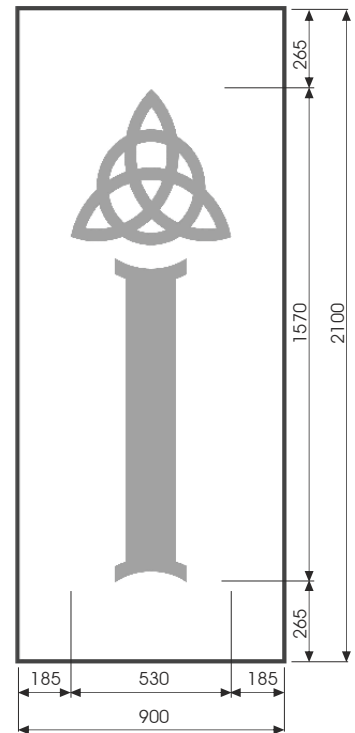



ULTRA FINE

PVC

AL





ULTRA FINE



DVF-209

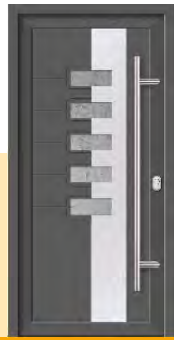

DVF-211



DVF-214



DVF-215



DVF-216

seite • page • pagina

103

104

105

106

107



DVF-219
GL219V1



DVF-220



DVF-222
GL222V1



DVF-225
GL225V1



DVF-226
GL226V1

seite • page • pagina

108

109

110

111

112



DVF-229
GL229V2

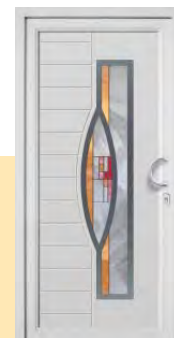

DVF-230
GL230V2



DV-287

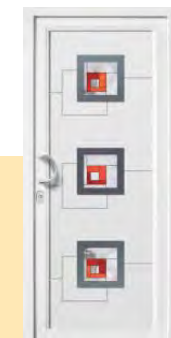

DVF-289
GL289V2

seite • page • pagina

113

114

115

116

PVC



Weiss
RAL 9003



Weiss
RAL 9016



Cremeweiss
1379-05 Renolit

AL



RAL



DVF-209 GL209V1



DVF-209

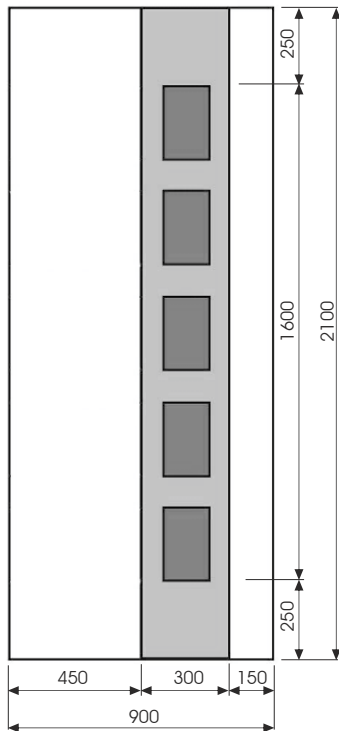

DVF-209



DVF-211



DVF-211

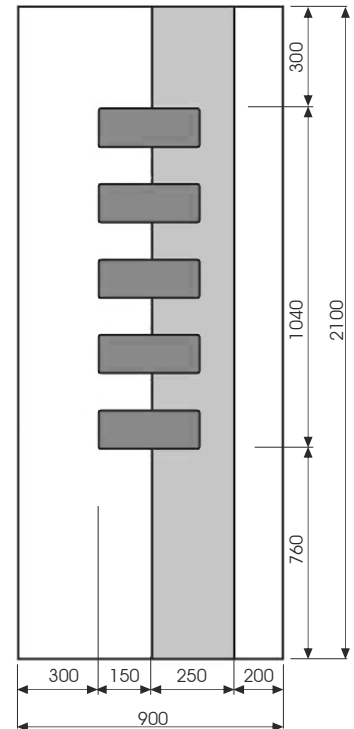



DVF-214

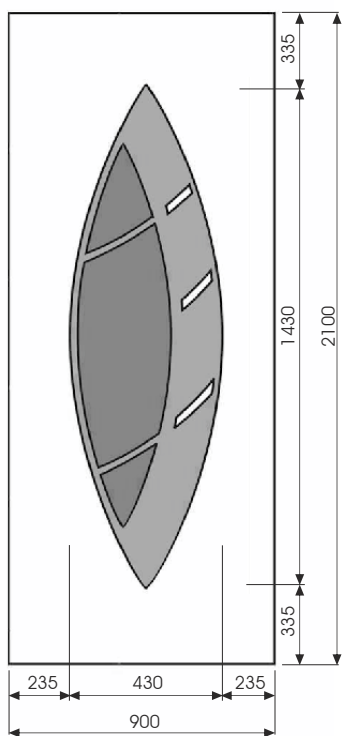

DVF-214



DVF-215 GL215V1



DVF-215



DVF-215

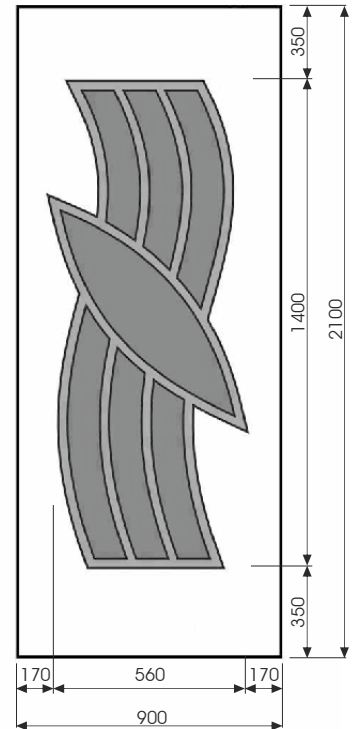



DVF-216

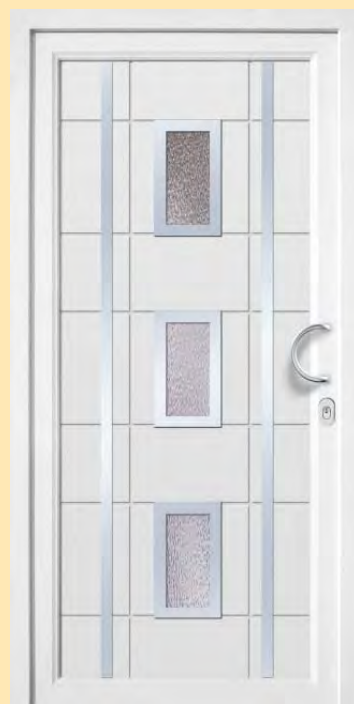
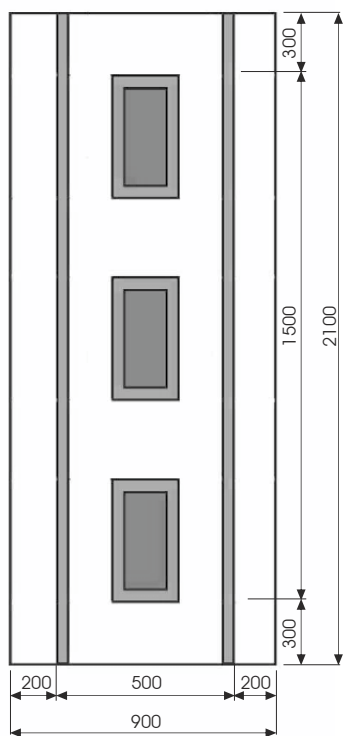

DVF-216



DVF-219 GL219V1



DVF-219



DVF-219 GL219V2

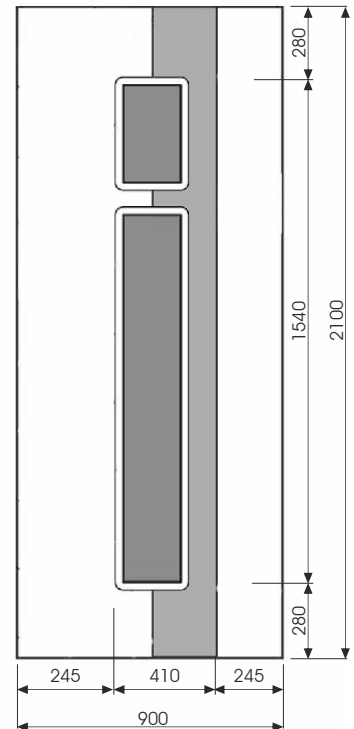



DVF-220

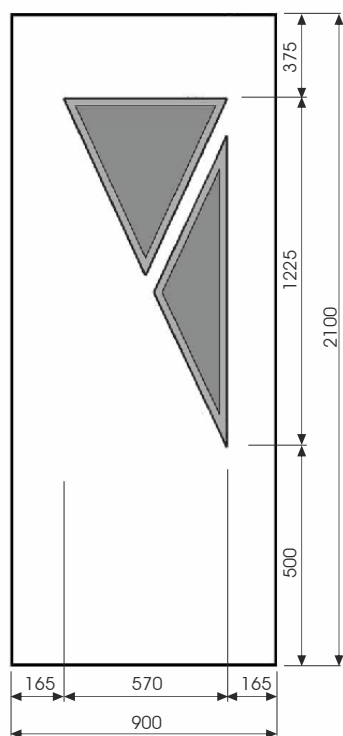

DVF-220 GL220P1



DVF-222 GL222V1



DVF-222



DVF-222

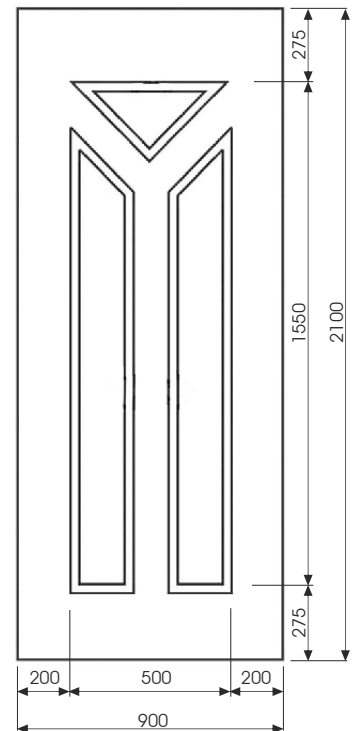



DVF-225 GL225V1



DVF-225

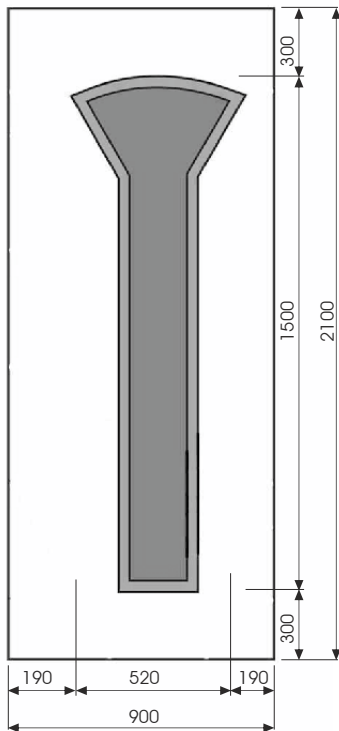

DVF-225



DVF-226 GL226V1

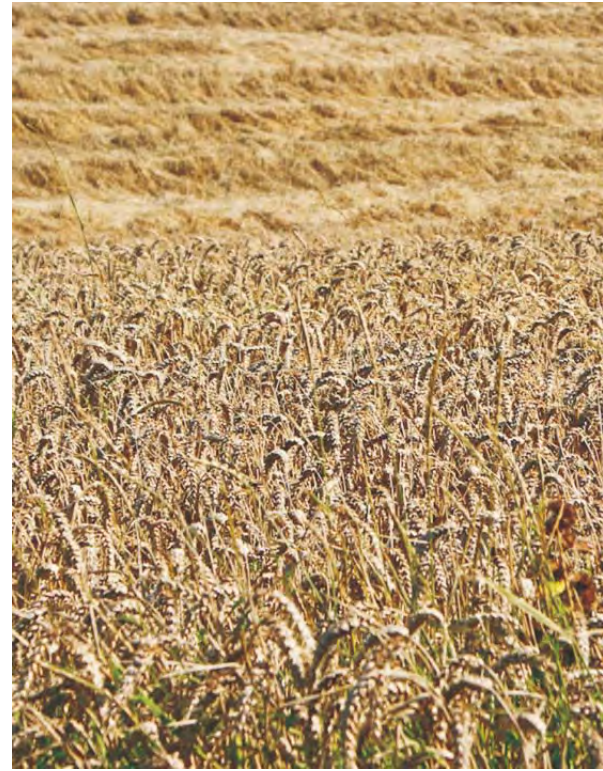

DVF-226



DVF-226



DVF-226 GL226V2

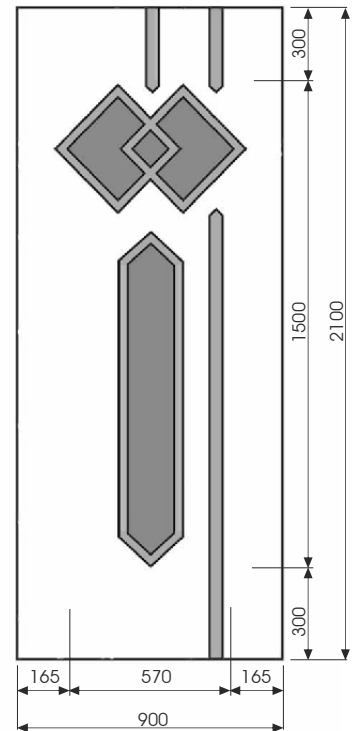



DVF-229 GL229V2



DVF-229

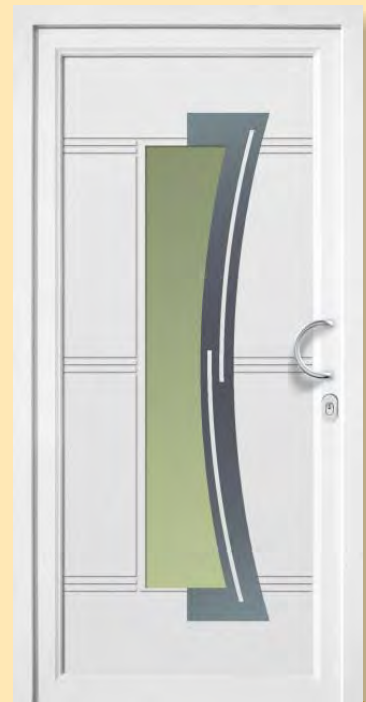
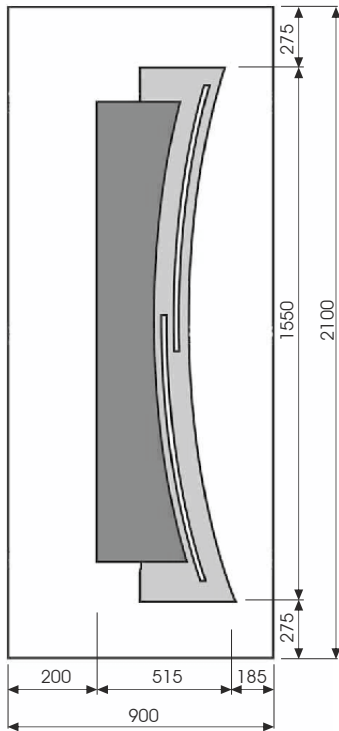

DVF-229



DVF-230 GL230V2



DVF-230



DVF-230

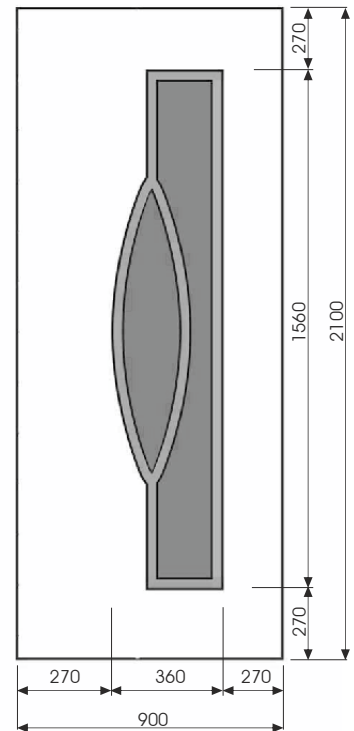



DVF-287

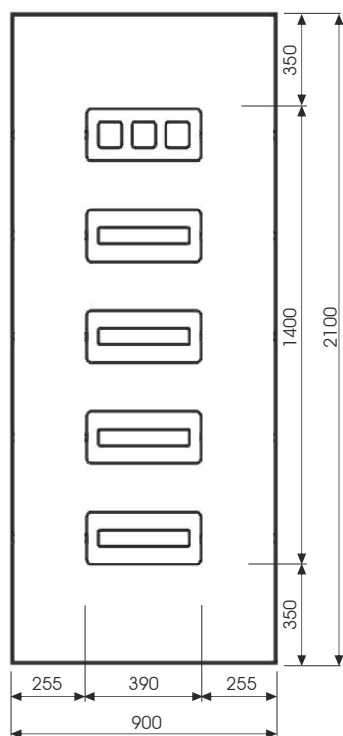

DVF-288



DVF-289 GL289V2



DVF-289

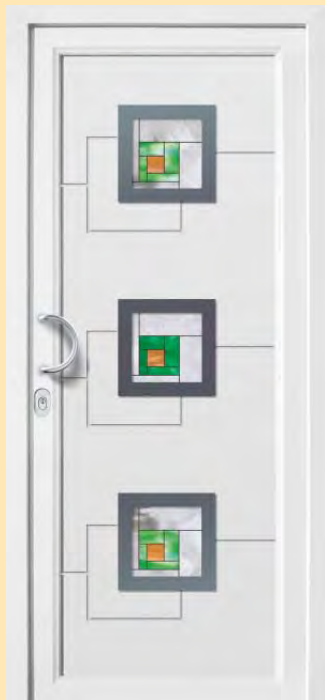

DVF-289 GL289V1



DVF-289

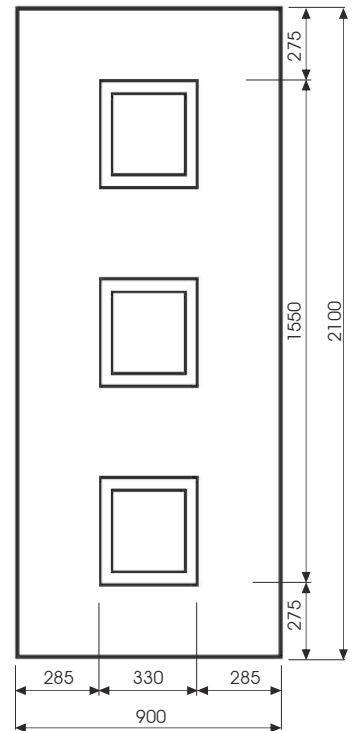

BK

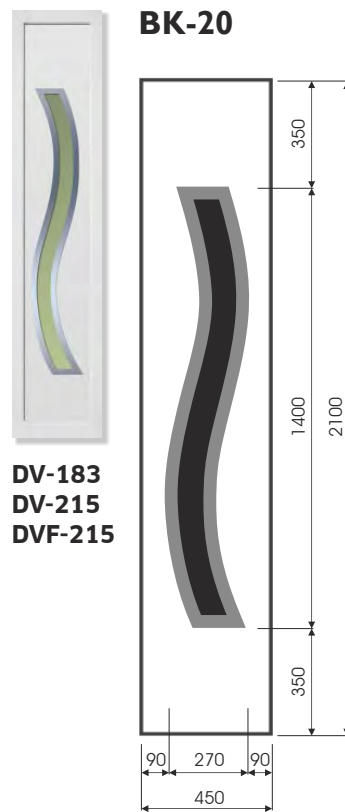
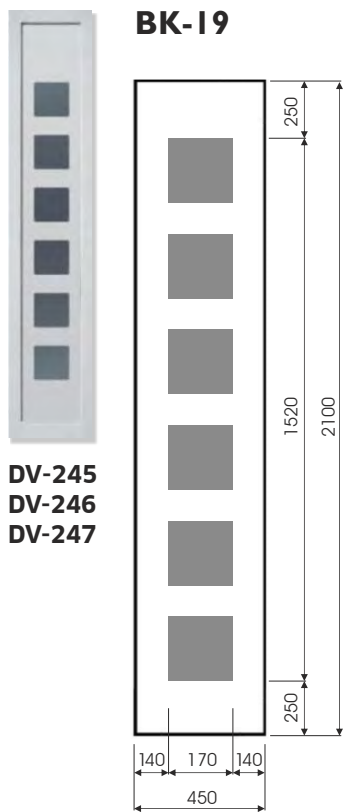
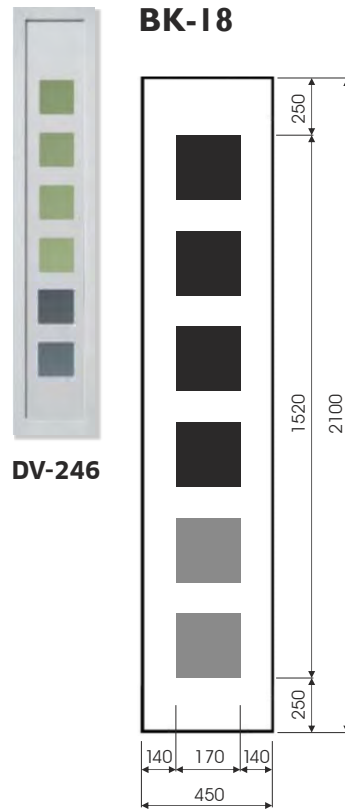
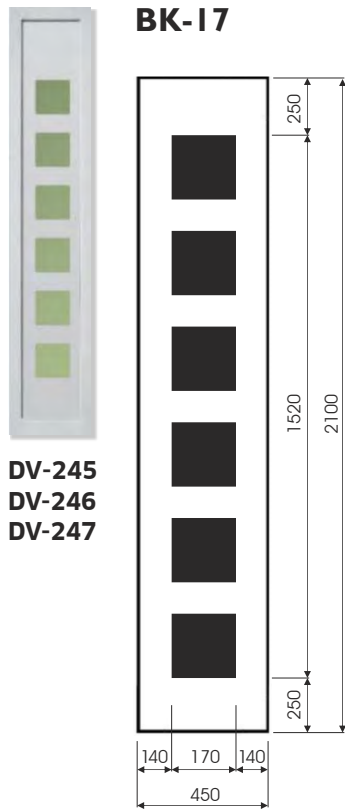

TÜRFÜLLUNGEN • DOOR PANELS • GARNISSAGES DE PORTE • PANNELLI PER PORTE

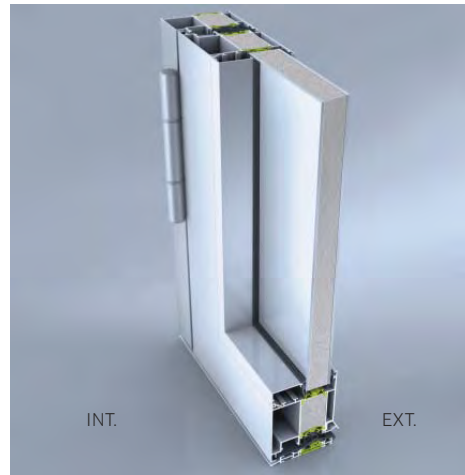

PVC
AL
HPL

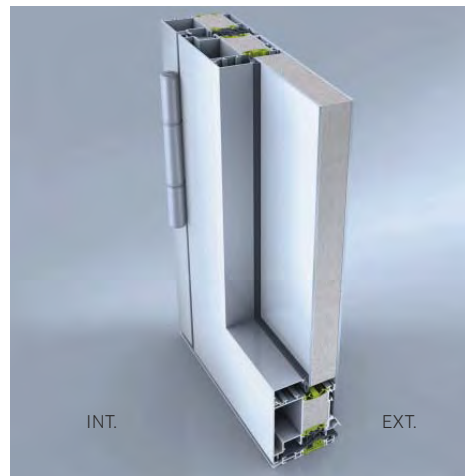

AL



AL

**FARBEN UND HOLZDEKORS • COLOURS AND WOODEN DECORATION
COULEURS ET DÉCORS • COLORI E DECORI**

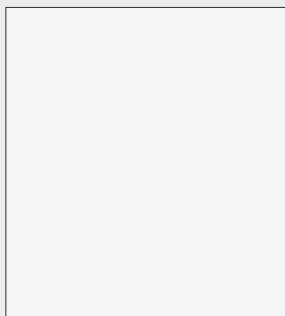

Weiss
RAL 9003

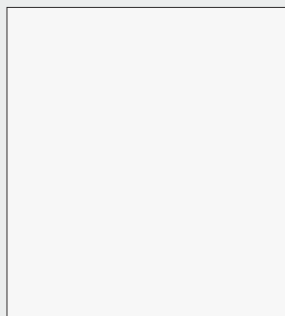

Weiss
RAL 9016



Cremeweiss
1379-05 Renolit

STÄRKE • THICKNESS • EPAISSEUR • SPESSORE

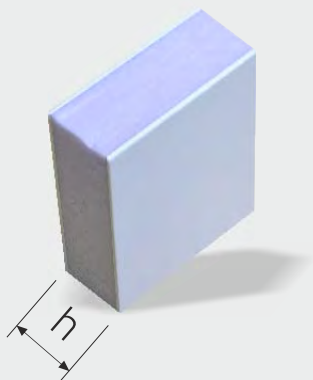

h (mm)					
24	33	36	40	44	48

DIMENSION • DIMENSIONE

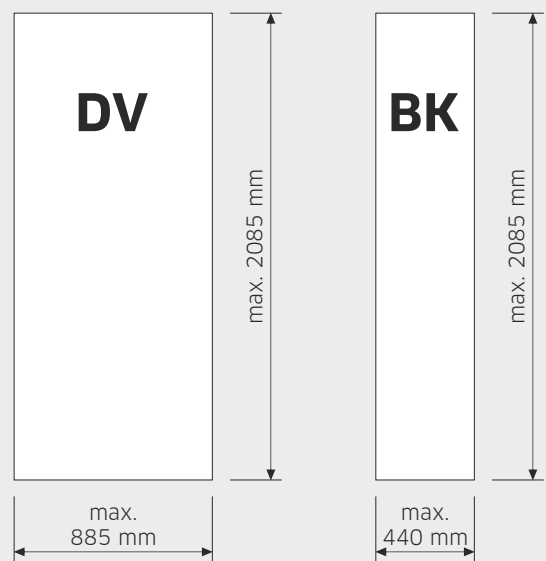

**FÜLLUNGSSTRUKTUREN • TYPES OF DOOR PANELS STRUCTURES
LES TYPES DE STRUCTURE DES PANNEAUX • TIPI DI STRUTTURA**

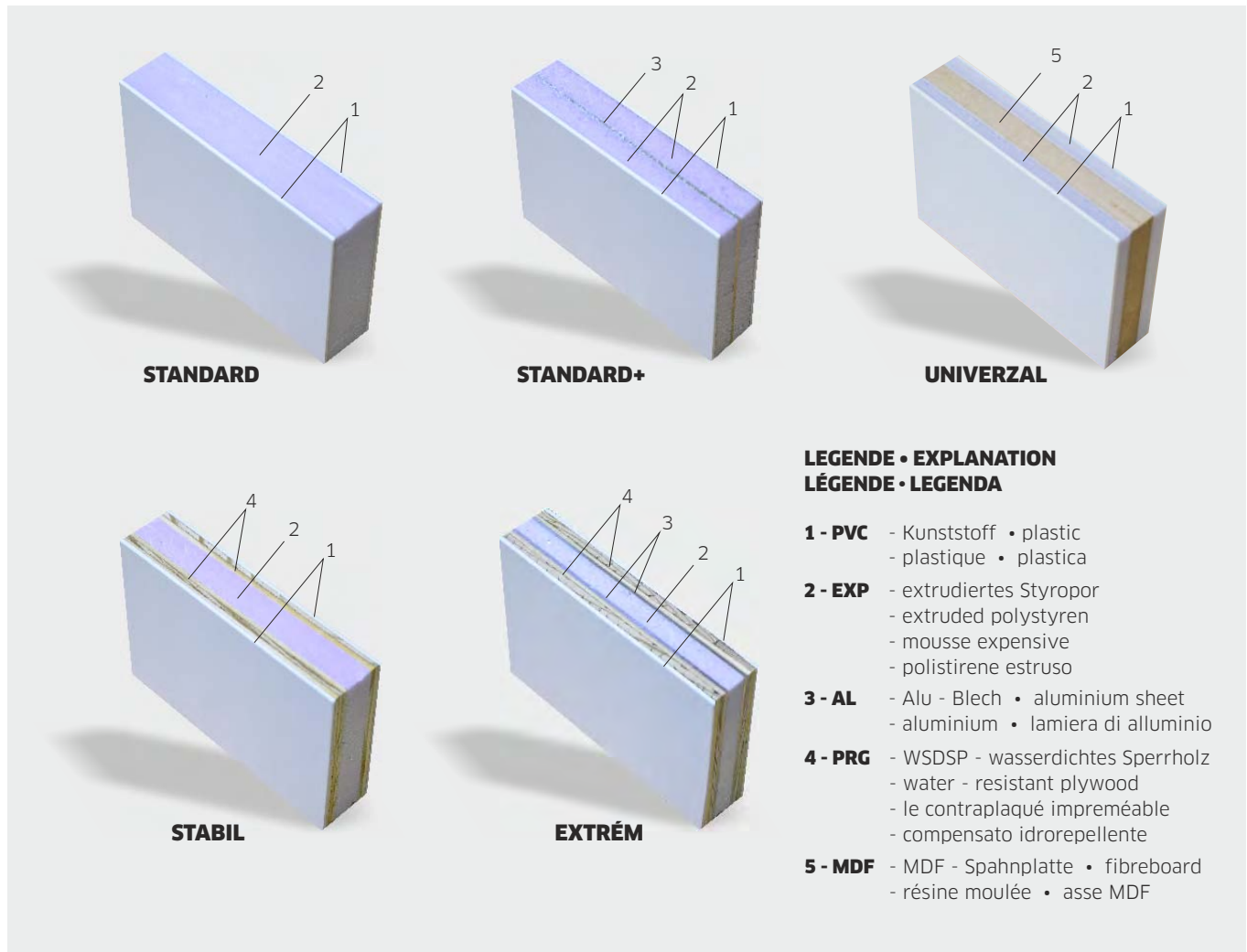

STANDARD **STANDARD+** **UNIVERZAL**

STABIL **EXTRÉM**

**LEGENDE • EXPLANATION
LÉGENDE • LEGENDA**

- 1 - PVC** - Kunststoff • plastic
- plastique • plastica
- 2 - EXP** - extrudiertes Styropor
- extruded polystyren
- mousse expansive
- polistirene estruso
- 3 - AL** - Alu - Blech • aluminium sheet
- aluminium • lamiera di alluminio
- 4 - PRG** - WSDSP - wasserdichtes Sperrholz
- water - resistant plywood
- le contraplaqué impreméable
- compensato idrorepellente
- 5 - MDF** - MDF - Spahnplatte • fibreboard
- résine moulée • asse MDF

RAHMENAPLIKATION • DECORATIVE FRAME • CADRE DÉCORATIF • TIPI DI INCORNICIATURE

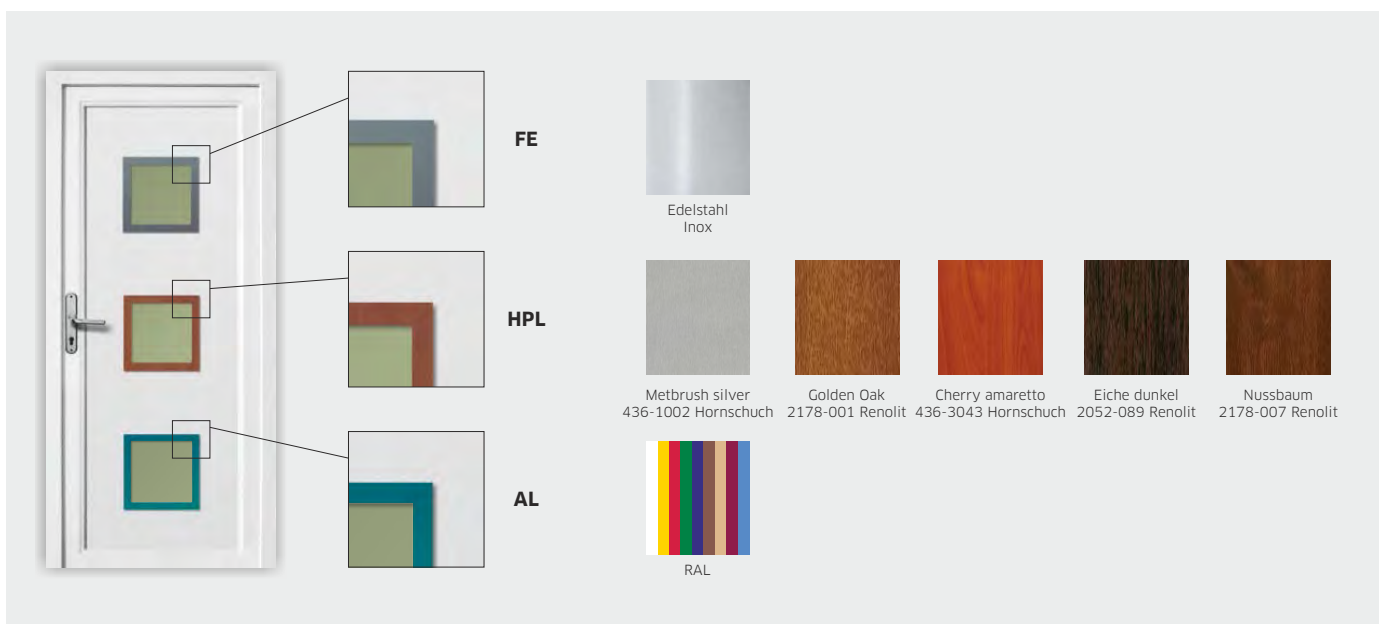

FE Edelstahl
Inox

HPL Metbrush silver Golden Oak Cherry amaretto Eiche dunkel Nussbaum
436-1002 Hornschuch 2178-001 Renolit 436-3043 Hornschuch 2052-089 Renolit 2178-007 Renolit

AL RAL

FARBEN • COLOURS • COULEURS • COLORI

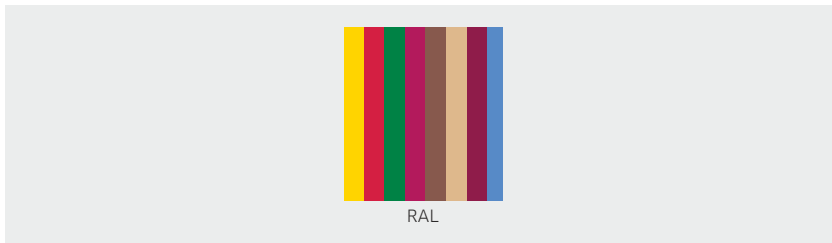

DIMENSION • DIMENSIONE

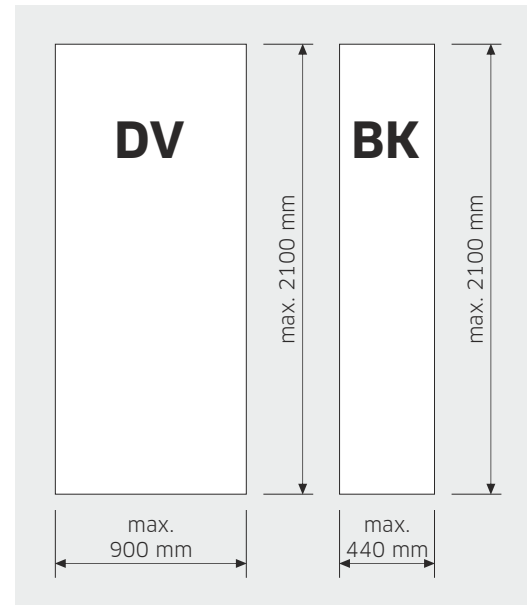

STÄRKE • THICKNESS • EPAISSEUR • SPESSORE

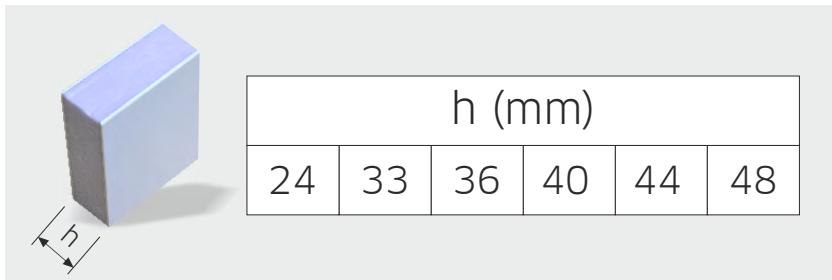

**FÜLLUNGSSTRUKTUREN • TYPES OF DOOR PANELS STRUCTURES
LES TYPES DE STRUCTURE DES PANNEAUX • TIPI DI STRUTTURA**

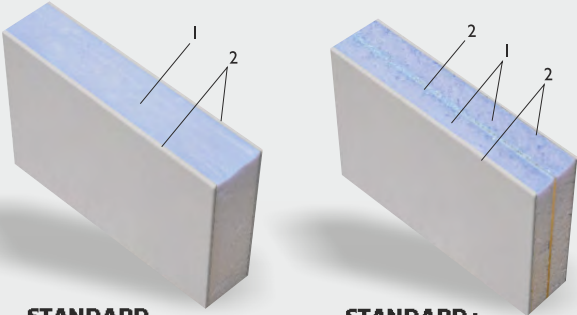



STANDARD **STANDARD+**



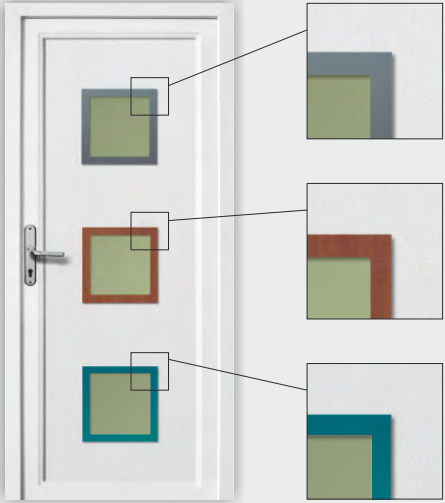

**LEGENDE • EXPLANATION
LÉGENDE • LEGENDA**

- 1 - XPS** - extrudiertes Styropor
- extruded polystyren
- mousse expansive
- polistirene estruso
- 2 - AL** - Alu - Blech • aluminium sheet
- aluminium • lamiera di alluminio

RAHMENAPLIKATION • DECORATIVE FRAME • CADRE DÉCORATIF • TIPI DI INCORNICIATURE

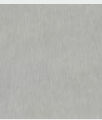

FE  Edelstahl
Inox

HPL  Metbrush silver
436-1002 Hornschuch  Golden Oak
2178-001 Renolit  Cherry amaretto
436-3043 Hornschuch  Eiche dunkel
2052-089 Renolit  Nussbaum
2178-007 Renolit

AL  RAL

**FARBEN UND HOLZDEKORS • COLOURS AND WOODEN DECORATION
COULEURS ET DÉCORS • COLORI E DECORI**



STÄRKE • THICKNESS • EPAISSEUR • SPESSORE

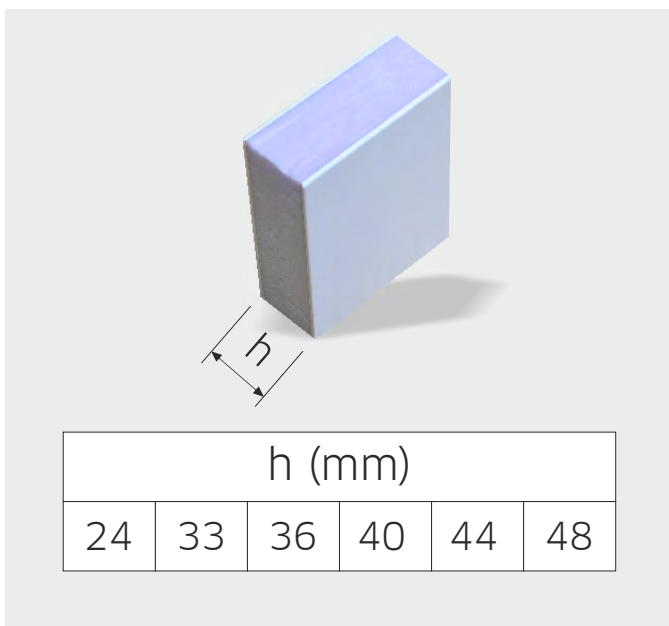

DIMENSION • DIMENSIONE

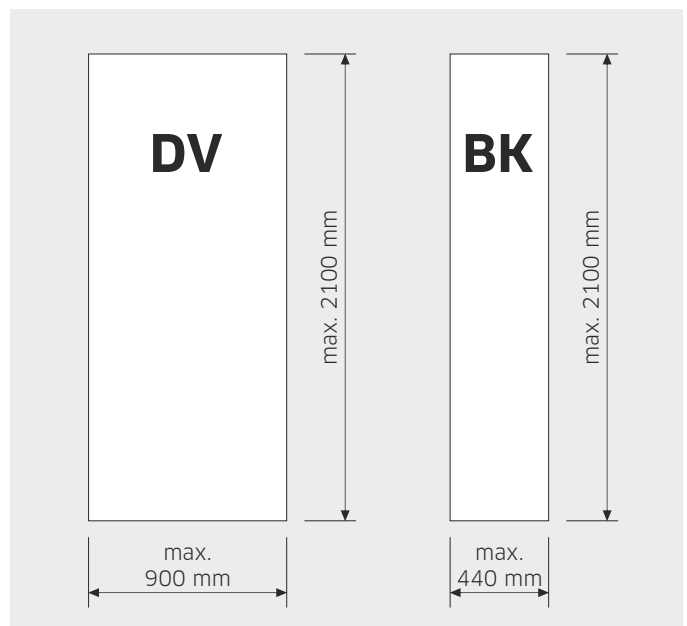

**FÜLLUNGSSTRUKTUREN • TYPES OF DOOR PANELS STRUCTURES
LES TYPES DE STRUCTURE DES PANNEAUX • TIPI DI STRUTTURA**

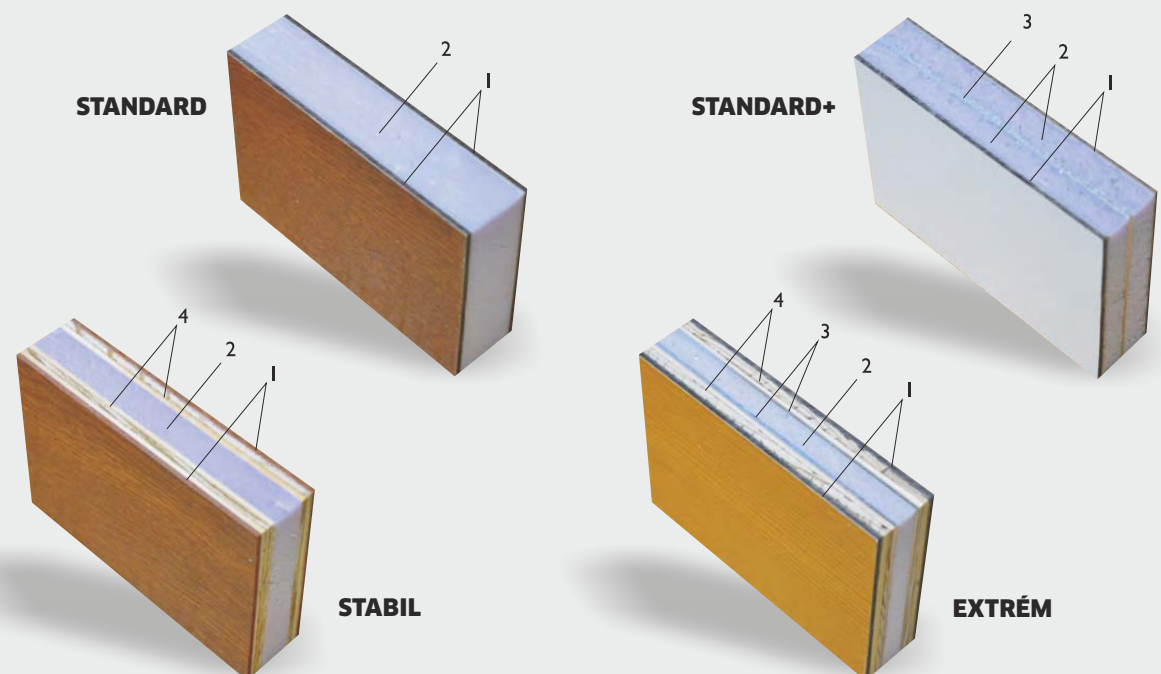

STANDARD

STANDARD+

STABIL

EXTRÉM

LEGENDE • EXPLANATION • LÉGENDE • LEGENDA

<p>1 - HPL - Kunstharz • compressed resin - résine moulée • resina pressata</p> <p>2 - XPS - extrudiertes Styropor • extruded polystyren - mousse expansive • polistirene estruso</p>	<p>3 - AL - Alu - Blech • aluminium sheet - aluminium • lamiera di alluminio</p> <p>4 - PRG - WSDSP - wasserdichtes Sperrholz - water - resistant plywood - le contraplaqué impremeable - compensato idrorepellente</p>
---	---

RAHMENAPLIKATION • DECORATIVE FRAME • CADRE DÉCORATIF • TIPI DI INCORNICIATURE

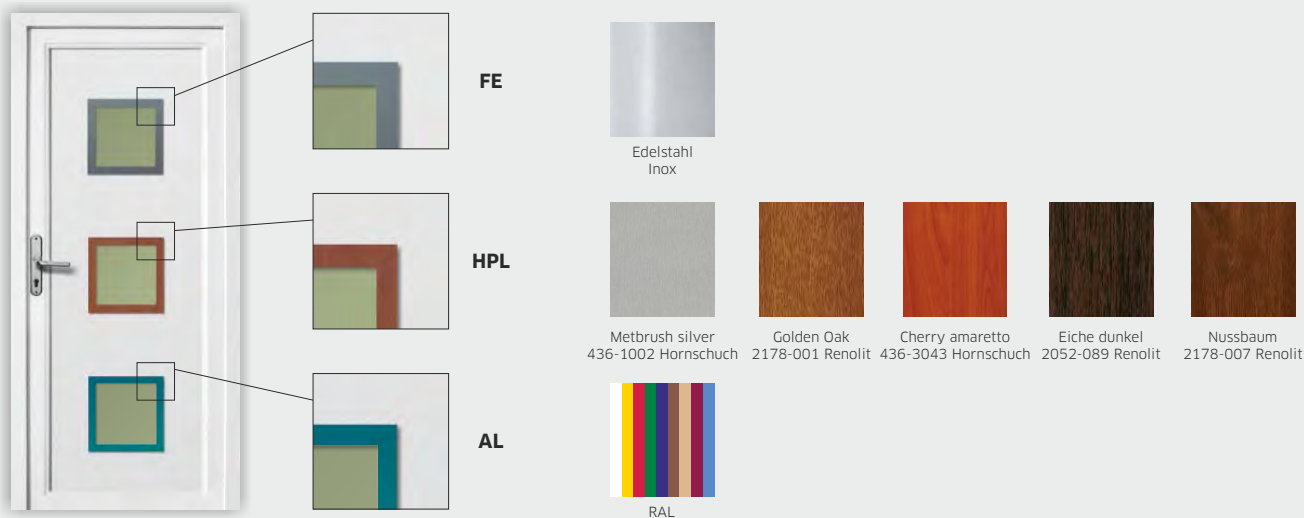

FE

Edelstahl
Inox

HPL

Metbrush silver
436-1002 Hornschuch

Golden Oak
2178-001 Renolit

Cherry amaretto
436-3043 Hornschuch

Eiche dunkel
2052-089 Renolit

Nussbaum
2178-007 Renolit

AL

RAL

PVC • AL • HPL 

ULTRA • SYMBOLS • ULTRA FINE

GLAS • GLASS • VERRE • VETRO

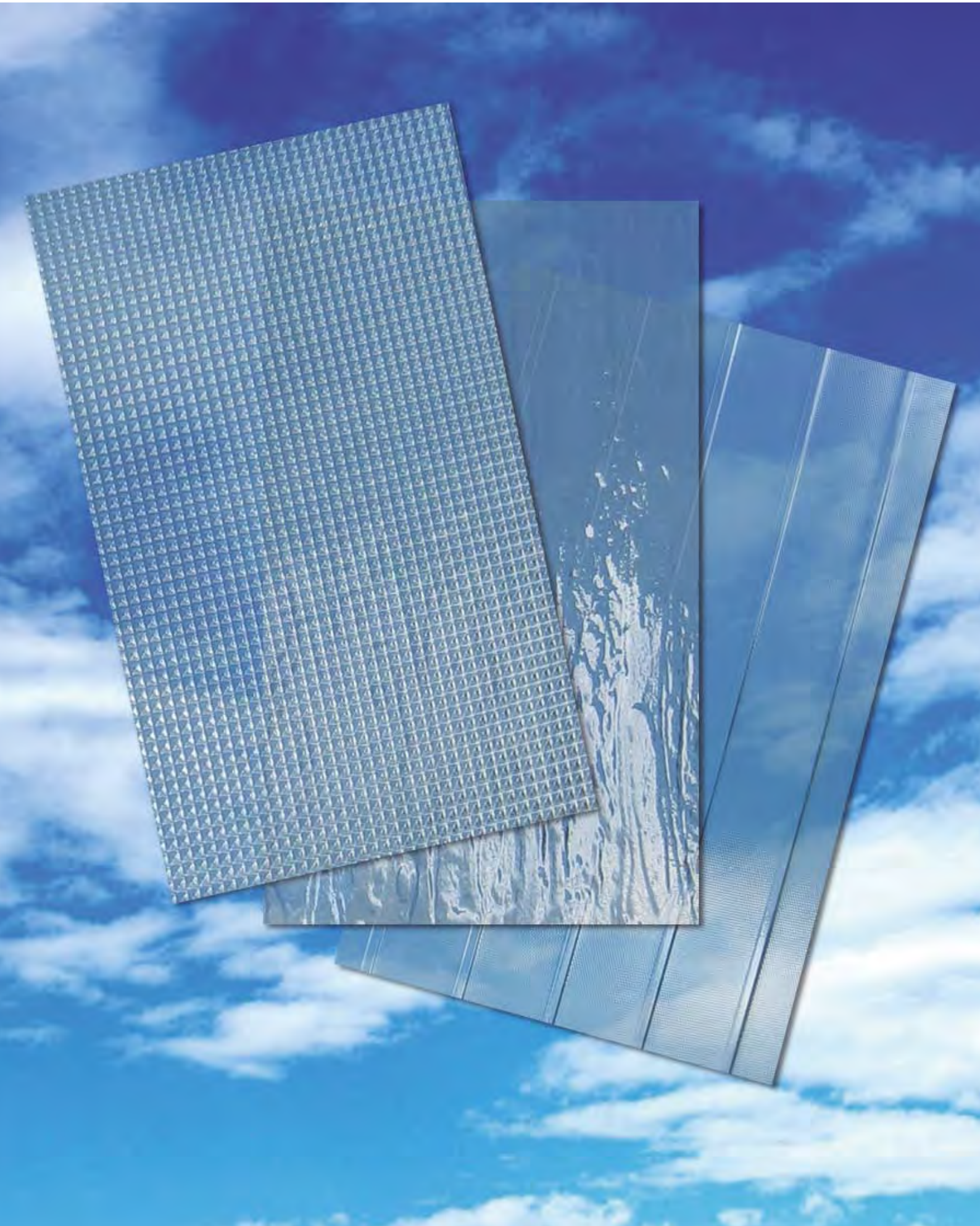

GLAS • GLASS • VERRE • VETRO

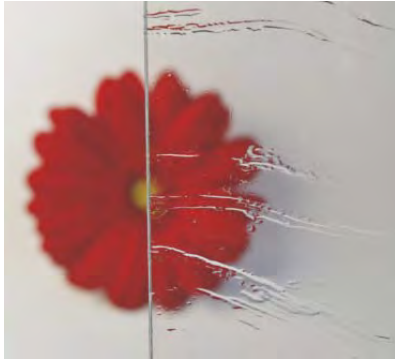

Altdeutsch klar



Altdeutsch bronze



Barok blau

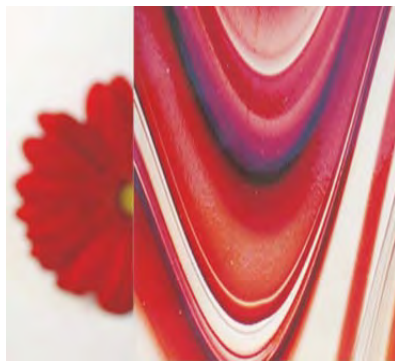

Burgundy (Barok braun)

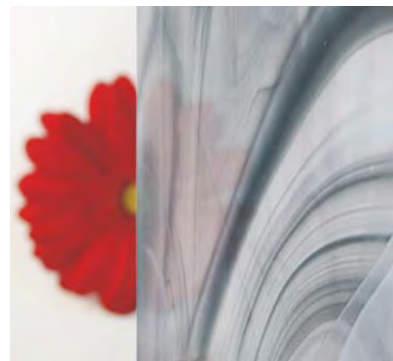

Barok schwarz

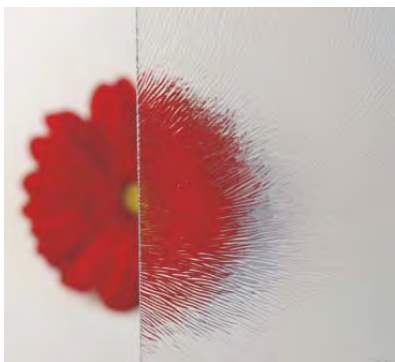

Chinchilla klar

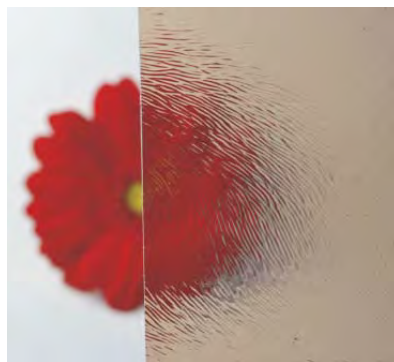

Chinchilla bronze

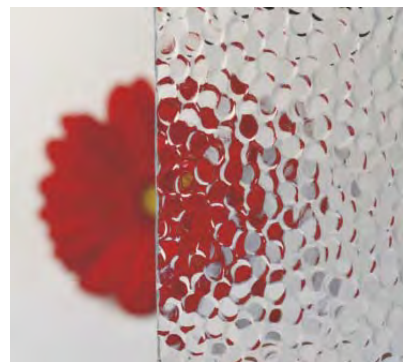

Confeta

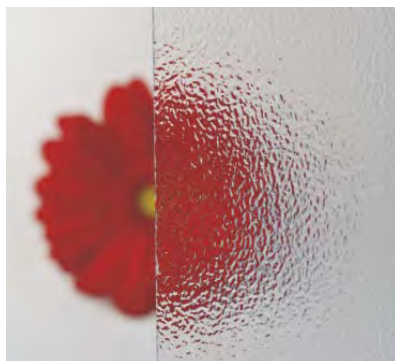

Crepi

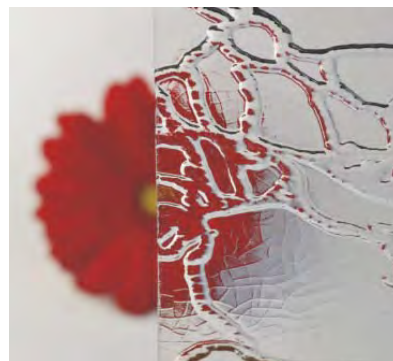

Delta klar

GLAS • GLASS • VERRE • VETRO

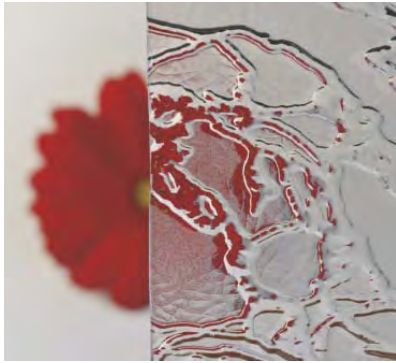

Delta klar matt

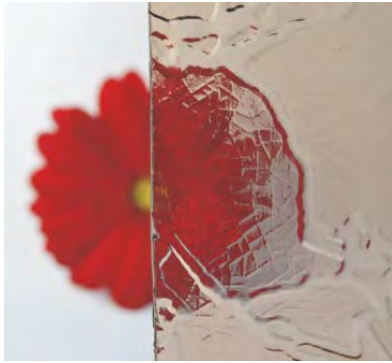

Delta bronze

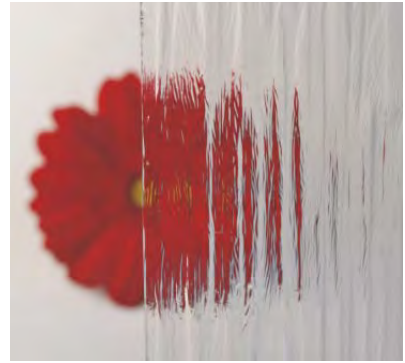

Eichenrinde klar



Eichenrinde bronze

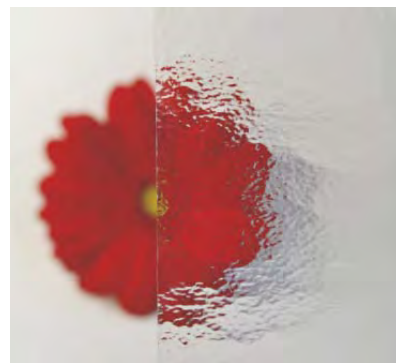

Kathedral chiaro

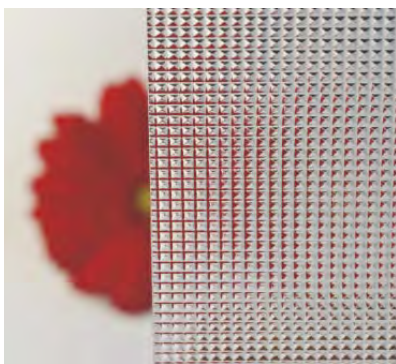

Krizet

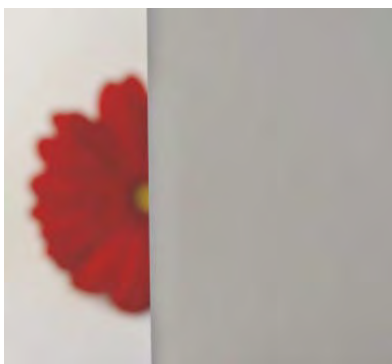

Lacomat (Satinato)

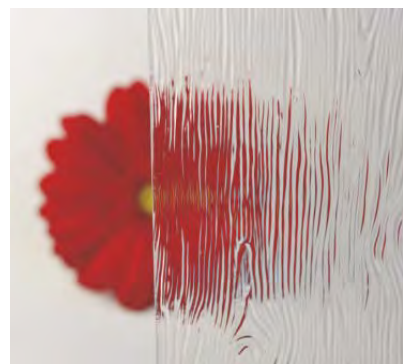

Madeira klar

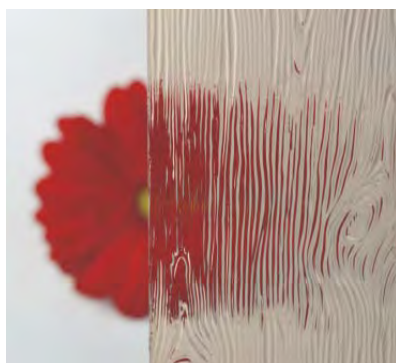

Madeira bronze

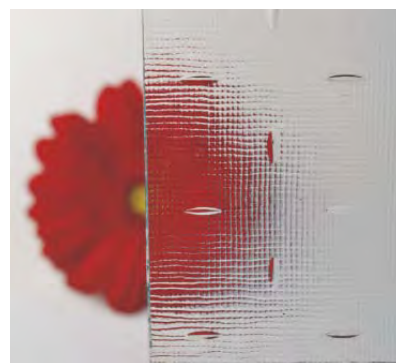

Maris

GLAS • GLASS • VERRE • VETRO

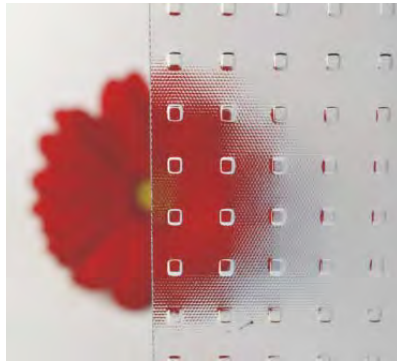

Master care

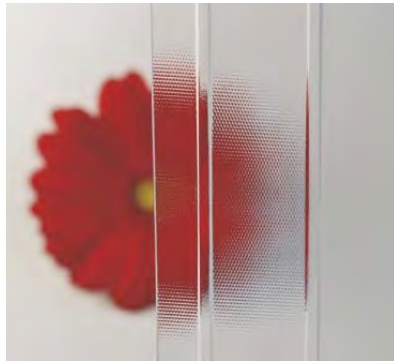

Master ligne

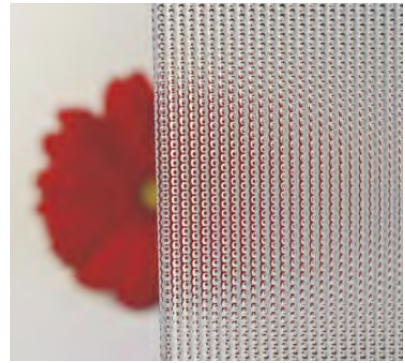

Master point

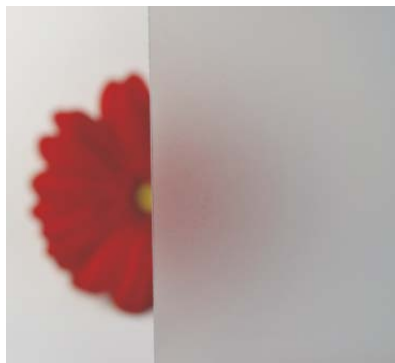

Matelux

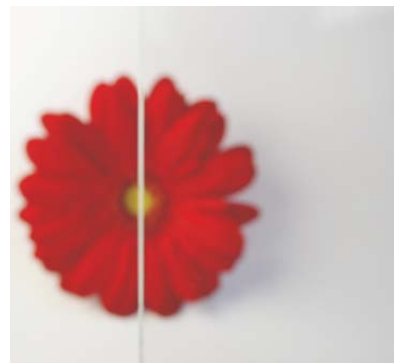

Planibel klar

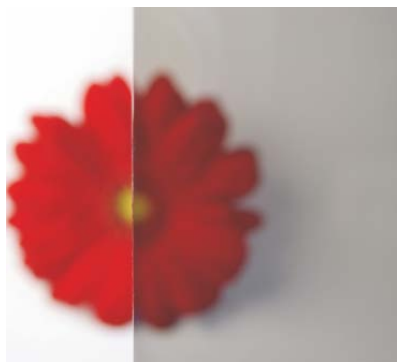

Planibel bronze

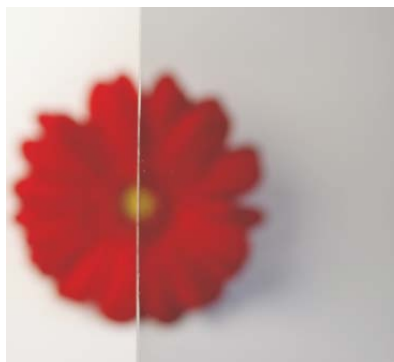

Planibel grau

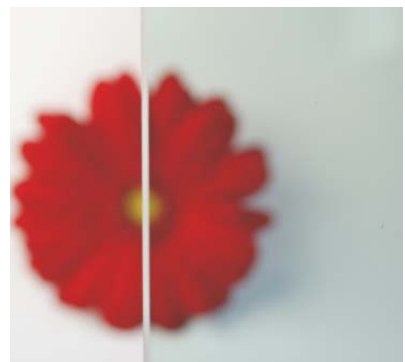

Planibel grün



Silvit klar



Silvit bronze

GLAS • GLASS • VERRE • VETRO

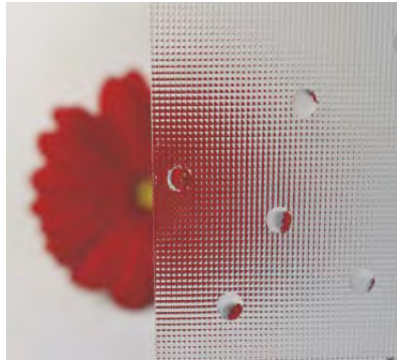

Spotlite

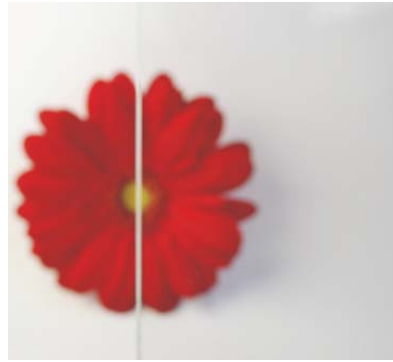

Stopsol klar

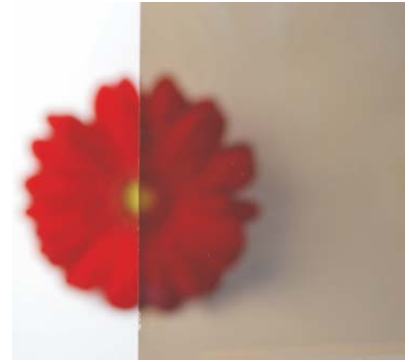

Stopsol bronze

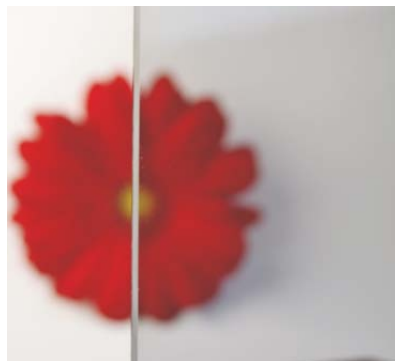

Stopsol supersilver klar

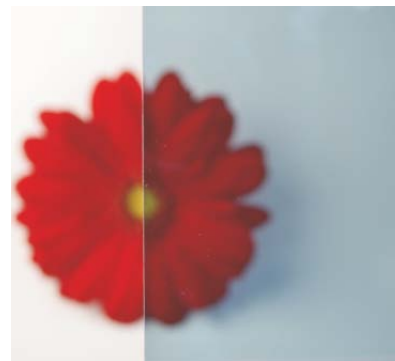

Stopsol supersilver azur

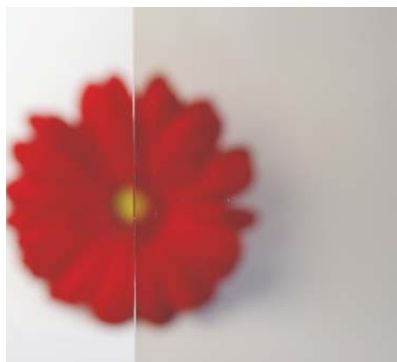

Stopsol supersilver grau

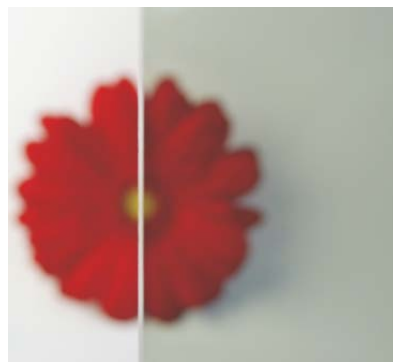

Stopsol supersilver grün

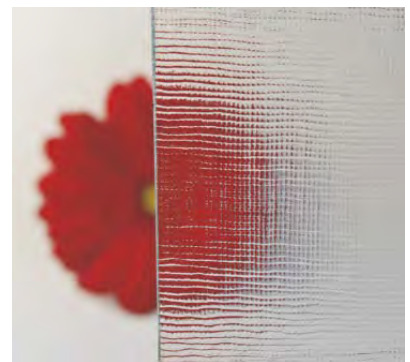

Thela



Super Spacer®

